



Building LXI-based Test Systems

Aug 3, 2013 Edition

Notice of Rights/Permissions: All rights reserved. This document is the property of the LXI Consortium and may be reproduced, but unaltered, in whole or in part, provided you retain the LXI copyright on every document page.

Table of Contents

BUILDING LXI-BASED TEST SYSTEMS	1
1 INTRODUCTION	3
2 EQUIPMENT AND SOFTWARE NEEDED.....	5
3 TEST SYSTEM LAN CONFIGURATION	6
3.1 OPEN SYSTEM CONFIGURATION USING SWITCH	7
3.2 ISOLATED SYSTEM CONFIGURATION USING ROUTER	8
3.3 ISOLATED SYSTEM CONFIGURATION USING DUAL NETWORK CARDS.....	9
3.4 WIRELESS ROUTER AND BRIDGE CONFIGURATION	10
3.5 ACCESSING LXI DEVICES REMOTELY VIA COMPANY INTRANET	11
3.6 ACCESSING LXI DEVICES REMOTELY VIA VPN CONNECTIONS	12
3.7 CONNECT, DISCOVER, AND IDENTIFY	13
3.7.1 No need to Register LAN Devices with DHCP Server	14
3.7.2 Must Register LAN Devices with DHCP Server	17
3.8 USING IP ADDRESS VS. HOSTNAME.....	22
4 CONTROLLING LXI DEVICES WITH IVI DRIVERS	24
5 TEST SYSTEM PERFORMANCE	26
6 TEST SYSTEM SECURITY	29
APPENDIX A. TROUBLESHOOTING	32
LAN STATUS FAULT INDICATION ON LXI DEVICE	32
CANNOT DISCOVER LXI DEVICE WITH <i>LXI DISCOVERY TOOL</i>	34
NO IP ADDRESS WHEN CONNECTING TO THE COMPANY LAN	34
<i>LXI DISCOVERY TOOL</i> FINDS THE LXI DEVICE, BUT YOU CAN'T ACCESS THE WEB PAGE.....	34
APPENDIX B. ROUTER AND DUAL NIC FEATURES EXPLORED	35
ACCESSING TEST SYSTEM COMPUTER ON ISOLATED SIDE OF ROUTER.....	36
INTERNET CONNECTION SHARING BETWEEN DUAL NETWORK INTERFACES	37
APPENDIX C. OTHER METHODS OF CONTROLLING LXI DEVICES	39
C# EXAMPLE USING DIRECT I/O AND SCPI TO CONTROL LXI DEVICES.....	40
MIXING DIRECT I/O WITH IVI DRIVER	42
APPENDIX D. WHAT LXI CONFORMANCE MEANS	43

1 Introduction

LXI is the standard for LAN equipped instrumentation that helps reduce the time it takes to set up, configure, and debug test systems. LXI is an open, accessible standard based upon Ethernet that identifies specifications and solutions related to the functional test, measurement and data acquisition industries. Here are some key benefits of using LXI to build Test Systems:

- Leverages the telecommunication industry infrastructure
- Lowers test system cost
- Simplifies system integration
- Provides high performance
- Ensures broad instrument availability

The *LXI Primer*, found at [GuidesForUsingLXI](#), provides more information about the background and capabilities of LXI. It explains the base or Core capabilities of all LXI Devices, and it explains how LXI Devices can incorporate Extended LXI Features such as LXI Wired Trigger Bus, LXI Event Messaging, LXI Time Synchronization, LXI Timestamped Data, LXI Event Logs, and other capabilities.

The *LXI Getting Started Guide*, also found at [GuidesForUsingLXI](#), provides a great starting point for the first-time user of LXI Devices. Another document found at that location, *LXI Networking Basics*, introduces you to many of the interconnecting LAN Devices such as LAN Switches, Hubs, and Routers. In addition, the *Glossary of Networking Terms* can help with LAN terminology. Understanding the behavior of LXI Devices is the focus of those documents, for when you understand how a single LXI Device behaves, you are better equipped to integrate multiple LXI Devices into a Test System.

This document expands upon the information in the *LXI Getting Started Guide*, which focuses on connecting a computer to a single LXI Device in one of two configurations: *Open* and *Isolated System Configurations*, illustrated in Figure 1.1.

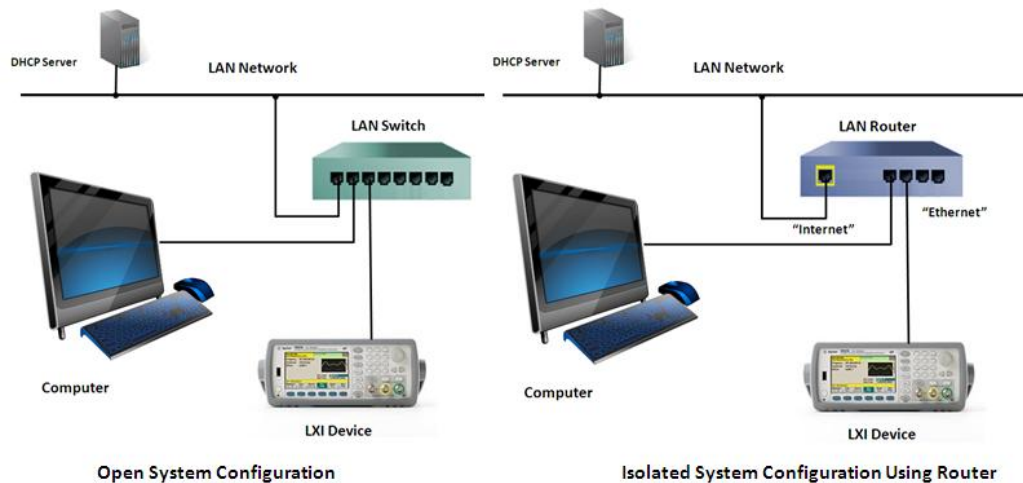

Figure 1.1 Open and Isolated System Configurations

The *Open System Configuration* has the benefit of allowing other users on the company LAN access to the computer and LXI Devices. The *Isolated System Configuration* keeps the LAN traffic away from the computer and LXI Device.

This document expands upon these two configurations and makes recommendations on LAN Configurations for building Test Systems using multiple LXI Devices. In addition, other recommended configurations include using Wireless, Site-to-Site (company Intranet), and VPN (Virtual Private Network). Software Control of LXI Devices, LAN Performance, and Security will round out the discussion for successfully building a Test System using LXI Devices.

Please Note: adding an LXI Device to the company LAN would involve the same process as adding a computer to the company LAN. LXI Devices are required to act the same.

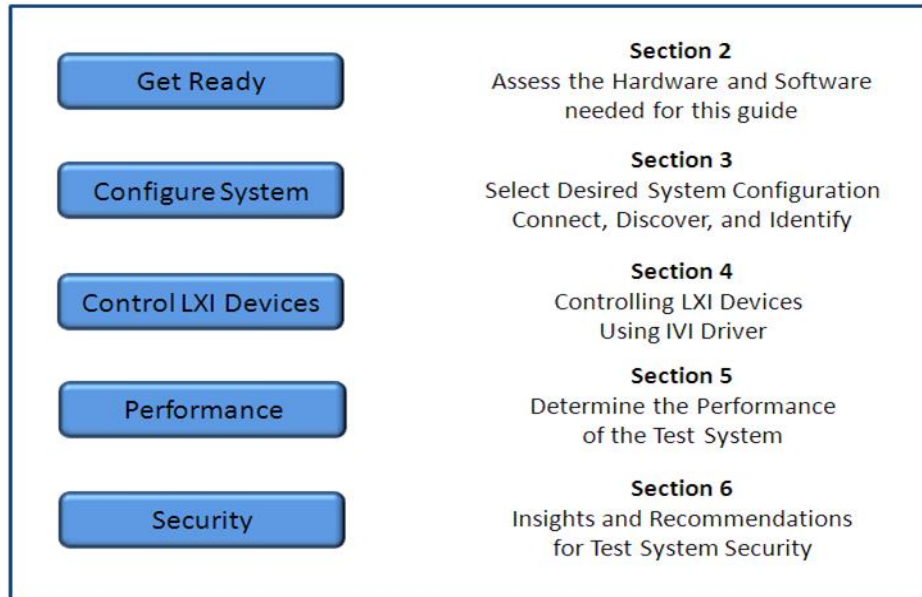

Figure 1.2 Summary of this Document

This document focuses on LAN Configurations and the interconnection of the test computer and LXI Devices. LAN offers so many devices and interconnecting techniques, and the Test System developer should understand the benefits and limitations offered by recommended LAN configurations.

The control of LXI Devices varies from product to product. With LXI Devices, the IVI Driver (Interchangeable Virtual Instruments), required as part of the LXI Conformance process, provides a common programming interface. IVI Drivers support the most popular software development environments such as Visual Studio C++, C#, Visual Basic 6 and .NET, National Instrument LabVIEW, National Instrument LabWindows/CVI, MathWorks MATLAB, and Agilent VEE Pro. With IVI Drivers, LXI Devices from different vendors and from different product families utilize this common interface to create a straightforward programming solution for test systems.

This document assumes you have more than a beginner's view of LAN. It also assumes you have some basic knowledge of an LXI Device's behavior on LAN. If not, please refer to the ***LXI Getting Started Guide***, found at [GuidesForUsingLXI](#), on the LXI Consortium website.

Performance, usability, maintainability, troubleshooting, and security are important aspects of building a successful LAN-based test system and covered in this document. However, a successful LAN-based test system must also play by the rules and requirements presented by your Network Administrator. The Network Administrator's job is to keep the LAN running smoothly and secure. The document ***Introducing LXI to your Network Administrator*** can help them understand the LAN protocols, services, security, etc. used by LXI Devices. This aids them understanding how the LXI Device behaves and what it requires to operate properly on the LAN. The Network Administrator

can then help you build and maintain the integrity and performance of your Test System. Find this document on the LXI Consortium Web site at [GuidesForUsingLXI](#).

2 Equipment and Software needed

The Hardware equipment specified in this document involves LAN devices that interconnect the computer and LXI Devices. Recommended LAN Configurations in *Section 3 Test System LAN Configuration* illustrate the LAN devices required and the interconnection methods.

The Software specified is oriented towards the development environments supported by the IVI Driver, since the LXI Standard requires an IVI Driver with each LXI Device. *Most* IVI Drivers require the VISA Library (Virtual Instrument Software Architecture), but some supply a specific interface library to communicate with their LXI Device. Multiple vendors such as Agilent, National Instruments, and Tektronix supply VISA with their hardware and/or software. (*Note: There may be a license fee to use a particular vendor's VISA if you have not purchased their software and/or hardware*) VISA is an industry standard communication protocol providing the interface between the User's program and the various I/O capabilities of a computer system, one of which is LAN for LXI Devices.

Here is a summary of required Hardware and Software in building an LXI-base Test System:

Hardware:

- LAN Devices – LAN cables, Switches, Routers, Wireless Access Points, etc., as listed for each LAN Configuration in *Section 3 Test System LAN Configurations*.
- Choose LAN Devices that match the 10Base-T, 100Base-T, or Gigabit Ethernet transmission speed of your LXI Devices. Refer to LXI Device documentation.

Software:

- IVI Driver for specific device control
- IVI Common components, usually included when installing vendor IVI Driver
- VISA Library or vendor-supplied Library to interface with LXI Device
- Device Discovery Tool, which helps in discovering LXI Devices

An LXI Device typically ships with a CD or DVD containing the VISA Library (or vendor-specific library) and example programs for various development environments, but you can download VISA from the following company URL's: www.agilent.com, www.ni.com, or www.tek.com. Once at the respective site, use the following search keywords: Agilent VISA, NI VISA, or TekVISA.

The Agilent, NI, or Tektronix VISA Library installation includes a Discovery Tool for finding the IP Address and Hostnames of LXI Devices: *Agilent Connection Expert*, *NI MAX*, or *TekVISA Discovery*. If desired, you can use that particular tool installed for discovering LXI Devices, and each company's installation includes documentation describing the use of their Discovery Tool.

This document only illustrates the *LXI Discovery Tool*, provided by the LXI Consortium at [GuidesForUsingLXI](#). *Download that tool now and follow the installation instructions provided on the Website.*

The IVI Foundation created a number of *IVI Getting Started Guides* for the development environments mentioned in *Section 1 Introduction*, which are available at www.ivifoundation.org. These guides provide how-to instructions for finding and installing the IVI Common components and IVI Drivers for devices. *Section 4 Controlling LXI Devices with IVI Drivers* summarizes the benefits, use models, and various development environments. For examples and information on controlling LXI Devices without IVI Drivers, refer to *Appendix D. Other Methods to Control LXI Devices*.

3 Test System LAN Configuration

This section walks through six recommended LAN configurations for building LXI-based Test Systems. Each configuration has particular Benefits and Cautions. Choosing a particular LAN Configuration depends upon the Test System requirements. The possible criteria listed below may conflict with one another and require making tradeoffs. Create your own list of requirements using these criteria as a starting point, and then move to *Sections 3.1 to 3.6* and choose a LAN Configuration that works best for your requirements.

Possible criteria when selecting a LAN Configuration

- Does the Test System require access by multiple users on the company LAN for test development, configuration, debugging, and monitoring?
- Should the Test System protect against interruptions while running tests?
- Does the Test System require stable or repeatable IP Addresses for all LAN Devices?
- Must the Test System apply company Security Standards?
- Does the Test System computer require regular backups?
- Do the Test System test results need to be stored on a company LAN Database Server?
- Are there one or more LXI Devices positioned away from the Test System due to hazards, ground plane differences, or distance?

Recommended LAN Configurations

- *Section 3.1 - Open System Configuration Using Switch*
- *Section 3.2 - Isolated System Configuration Using Router*
- *Section 3.3 - Isolated System Configuration Using Dual Network Cards*
- *Section 3.4 - Wireless Router and Bridge Configuration*
- *Section 3.5 - Accessing LXI Devices Remotely via Company Intranet*
- *Section 3.6 - Accessing LXI Devices Remotely via VPN Connections.*

After selecting your configuration, move to *Section 3.7 Connect, Discover, and Identify* as the next step in collecting the necessary LXI Device information and preparing to control those LXI Devices.

3.1 Open System Configuration Using Switch

This configuration provides open access of the Test System computer and LXI Devices to all users on the LAN. It permits multiple users to develop tests using the Test System. All LXI Devices acquire an IP Address from the company DHCP Server.

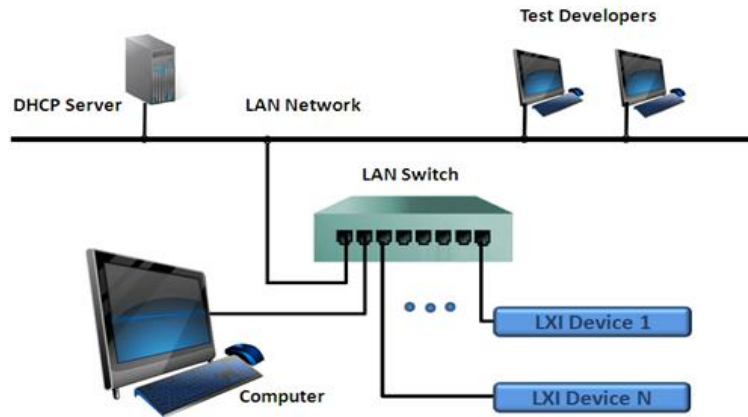

Figure 3.1 Open System Configuration Using Switch

Equipment	<ul style="list-style-type: none"> • LAN Switch with enough ports for all LXI Devices and computer • LAN Cables for all devices and connection to company LAN
Benefits	<ul style="list-style-type: none"> • Test System is accessible by anyone on the company LAN • Users can develop, troubleshoot, and execute tests from their own computer instead of only using the Test System computer • Users can monitor activity of LXI Device using a Web browser • Network Administrator has complete access to Test System computer for security updates and backup
Cautions	<ul style="list-style-type: none"> • Traffic on company LAN affects performance of Test System. • Active tests may be interrupted by other users accessing the Test System computer or the LXI Devices, including accessing their Web pages • Each device in the Test System requires IP Address from company DHCP Server • IP Addresses can change with re-configuration of DHCP Server • Security updates and backups may affect Test System performance and should be coordinated to times when the Test System is not in use • LXI Devices with a commercial operating system like Windows on their embedded computer may also require coordinated updates to avoid interrupting tests

3.2 Isolated System Configuration Using Router

This configuration hides the Test System computer and LXI Devices from the LAN. It isolates the Test System from the LAN to avoid performance degradation or interruption of tests. Only the Router acquires an IP Address from the company DHCP Server.

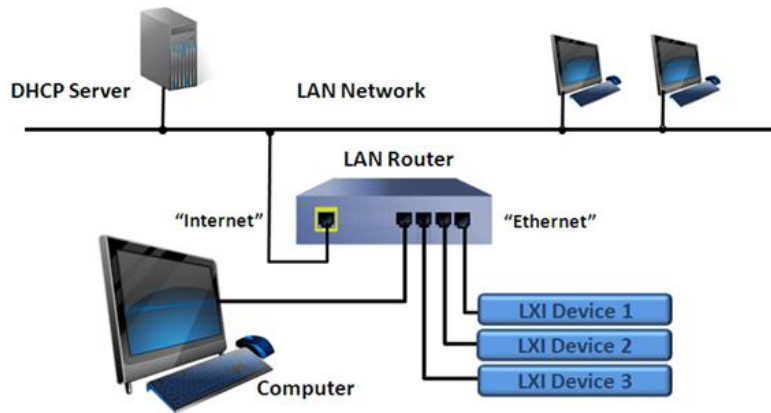

Figure 3.2 Isolated System Using LAN Router

Equipment	<ul style="list-style-type: none"> • LAN Router with enough ports for all LXI Devices plus computer, and include a LAN Switch to extend the number of ports. • LAN Cables for all devices and connection to company LAN
Benefits	<ul style="list-style-type: none"> • Test System and computer are isolated from LAN users and traffic which maintains performance of Test System with no interruption of tests • Test System computer can maintain a fixed operating system revision that is not changed automatically by Network Administrator software • Single IP Address required from company DHCP Server while computer and LXI Devices receive their IP Address from the built-in DHCP Server of Router • Can configure Router to use MAC Address Cloning, enable Ping, and pass port requests to the computer to make it appear still on the LAN. • Router configurable to allow remote-login from external users
Cautions	<ul style="list-style-type: none"> • Network Administrator may lose access to Test System without special configuration of Router. • Loss of remote-login access by users without special configuration of Router • Ethernet port on Router should never be connected to company LAN • The company DHCP Server may not allow Router connected to LAN and will not assign IP Address • Loss of Domain Name Service (DNS) for using Hostnames on local network • <i>Appendix C Router and Dual NIC Features Explored</i> provides insight on how to make Test System computer visible to company LAN while LXI Devices remain hidden.

3.3 Isolated System Configuration Using Dual Network Cards

This configuration hides the Test System LXI Devices from the LAN but leaves the computer accessible. Test Developers can remote-login and develop tests, and LXI Devices are not affected by interrupts from LAN traffic.

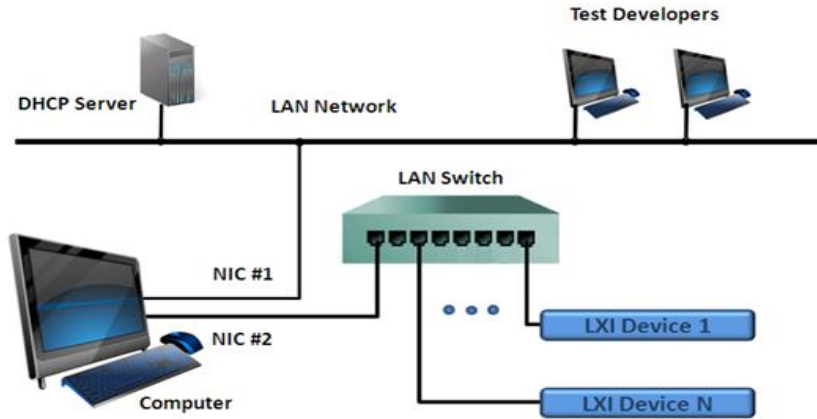

Figure 3.3 Isolated System Using Dual Network Cards

Equipment	<ul style="list-style-type: none"> • Two NIC (Network Interface Card) interfaces on computer • LAN Switch with enough ports for LXI Devices and computer • LAN Cables for all devices and connection to company LAN
Benefits	<ul style="list-style-type: none"> • LAN Interface NIC #1 of computer connected to LAN, so company DHCP Server does not see LXI Devices on NIC #2. • Users can remote-login to Test System computer to control LXI Devices • Network Administrator has access to computer for security updates and backup • LXI Devices isolated from LAN users and broadcast traffic • Single IP Address required from DHCP Server for computer. • LXI Devices can use static IP Address or AutoIP Address or can run software DHCP Server installed for NIC #2
Cautions	<ul style="list-style-type: none"> • Loss of Domain Name Service (DNS) for using Hostnames on local network • Viruses introduced into LXI Devices can infect computer through NIC #2. Computer must have way of cleaning viruses from NIC #2 subnet • LXI Devices need computer support between NIC's, such as Internet Connection Sharing (ICS), to access Internet through Gateway for updates • <i>Appendix C Router and Dual NIC Features Explored</i> provides insight on installation, use models, and using static IP, AutoIP, ICS, and DHCP IP Addressing.

3.4 Wireless Router and Bridge Configuration

This configuration demonstrates how to overcome environmental hazards, wiring difficulties, or distance limitations while providing a reasonable method to maintain LAN security using wireless communication in combination with Dual NIC interfaces. The Dual NIC provides an extra level of isolation to block wireless access to LAN.

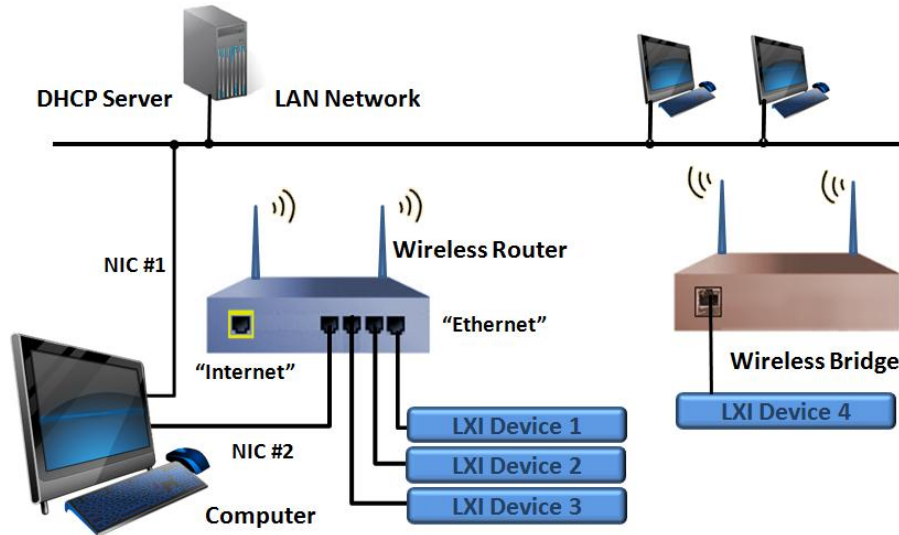

Figure 3.4 Wireless Router and Bridge Configuration

<p>Equipment</p>	<ul style="list-style-type: none"> • Wireless Router with enough ports for all LXI Devices and computer, and add Switch to port on Router to extend ports for additional LXI Devices • Wireless Bridge or Access Point as Bridge for remote LXI Device • LAN Cables for all devices and connection to company LAN • Two NIC interfaces or use wireless on computer for connection to company LAN and single NIC for connection to Router
<p>Benefits</p>	<ul style="list-style-type: none"> • All the benefits of <i>Isolated System Configuration Using Router</i> • Wireless WPA2 security and no Router connection to company LAN offers good security • Remote LXI Device can be located on moving structure, in toxic/hazardous environment, differing ground potentials, at a distance from Test System, etc. • Significant cost savings when avoiding long-distance wiring and complexities for the above listed use cases.
<p>Cautions</p>	<ul style="list-style-type: none"> • All the cautions of <i>Isolated System Configuration Using Router</i> • Wireless configurations may not be allowed or possible in some environments • Wireless connections share bandwidth, which can degrade performance. • <i>Appendix C Router and Dual NIC Features Explored</i> discusses other topics related to Routers.

3.5 Accessing LXI Devices Remotely via Company Intranet

This configuration permits users to access equipment at different company sites. Users at one site can develop, troubleshoot, and monitor Test Systems installed at another site, even sites in different parts of the world. Users must know the remote LXI Device IP address in order to access it and may need help in determining these IP addresses.

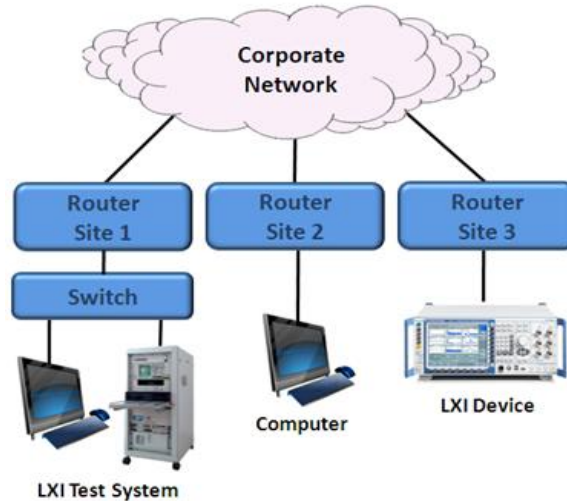

Figure 3.5 Configuration Using Company Intranet

Equipment	<ul style="list-style-type: none"> • See <i>Section 3.1 Open System Configuration Using Switch</i> • Company intranet that provides access between sites
Benefits	<ul style="list-style-type: none"> • An extension of benefits for <i>Open System Configuration Using Switch</i> where users are now at other physical sites within the company intranet • All communication exists behind the company Firewall • Engineering and Test Development may be on one site and Production at a different site. Developers can monitor and troubleshoot Test System without traveling to remote site. Users need only communicate IP Addresses to each other • Training and consulting on complex instrumentation can occur remotely • Antenna testing works for this configuration since the Test System signal source can transmit through air with the receiver controlled through intranet at remote site
Cautions	<ul style="list-style-type: none"> • Extension of cautions for <i>Open System Configuration Using Switch</i> • Unless a virtual private LAN implemented, users at different sites must inform each other of LAN IP Addresses, since the <i>LXI Discovery Tool</i> cannot discover LXI Devices on different subnets • LAN performance limited by network interconnect speeds between source and destination

3.6 Accessing LXI Devices Remotely via VPN Connections

This configuration permits a user to access the Test System from anywhere in the world. A user can develop, troubleshoot, and monitor a Test System from outside the company intranet. This is a typical configuration for employees accessing the company LAN while at home or traveling.



Figure 3.6 Configuration Using VPN Connections

Equipment	<ul style="list-style-type: none"> • Access to WAN (Wide Area Network – the Internet) • See <i>Section 3.1 Open System Configuration Using Switch</i> • VPN (Virtual Private Network) hardware and software • Allows to penetrate the corporate the firewall
Benefits	<ul style="list-style-type: none"> • An extension of benefits for <i>Open System Configuration Using Switch</i> where a single user can now access the Test System from anywhere • VPN (Virtual Private Network) extends the company intranet across the Internet so remote user is virtually on the company LAN. User can access Test System directly from remote computer or can remote-login to Test System computer. Remote-login to Test System computer provides user ability to run test programs at speed of Test System. • Provides developers access to Test System while traveling or from home
Cautions	<ul style="list-style-type: none"> • This configuration requires extensive support from the Network Administrator but is typical with today’s workforce working remotely. • Running test programs on remote computer could be very slow and cause timeouts and test failures

3.7 Connect, Discover, and Identify

The first four configurations, *Section 3.1 – 3.4*, represent subsets of *Section 3.5* and *3.6*, so we need only focus on those first four in this section. The *LXI Getting Started Guide* covers the topic of connecting LXI Devices to the company LAN using similar configurations with one LXI Device. The challenges are the same here but with more LXI Devices. For some companies, any LAN Device can be connected to the LAN and receive an automatic IP Address assignment from the DHCP Server. However, other companies have restrictions on which LAN Devices receive IP Addresses. Refer to the *LXI Getting Started Guide* at [GuidesForUsingLXI](#) for more details on these restrictions.

Whether it is easy or difficult to add LAN Devices to the company LAN, the same information collection process applies in preparing to control LXI Devices. That is, we want to obtain the Hostname of the LXI Device and use that rather than the IP Address to control the device. An LXI Device with a Front Panel and interface would allow access to its LAN Configuration to obtain the Hostname. However, many LXI Devices do not have Front Panels with displays for this information. Therefore, use the *LXI Discovery Tool* to find LXI Devices and then bring up the Web page to find the information.

If the company LAN *does not* require you register the LAN Device MAC Address before the DHCP Server will assign an IP Address, follow *Subsection 3.7.1*, summarized below:

- Connect computer and LXI Devices according to selected LAN Configuration
- Run the *LXI Discovery Tool* to find LXI Devices
- Open each LXI Device Web page to determine its Hostname
- If you want to confirm the device displaying the Web page, use the *LXI Identify*, found on the Home page of the LXI Device
- Use final IP Address or Hostname when controlling LXI Devices in *Section 4 Control LXI Devices with IVI Drivers*.

If the company LAN requires you register the LAN Device MAC Address before the DHCP Server will assign an IP Address, follow *Subsection 3.7.2*, summarized below:

- Connect computer and LXI Devices but remain disconnected from company LAN
- Run the *LXI Discovery Tool* to find LXI Devices
- Open each LXI Device Web page to determine Hostname and MAC Address
- If you want to identify which LXI Device you are accessing, use the *LXI Identify*, found on the Home page of the LXI Device
- If using a Router, determine its MAC Address
- If using Dual NIC Configuration, determine both NIC MAC Addresses
- Submit MAC Addresses to Network Administrator to register with the DHCP Server
- Reconnect to company LAN for acquiring IP Addresses from the DHCP Server
- Re-run *LXI Discovery Tool* to make sure each LXI Device is accessible to computer
- Use final IP Address or Hostname when controlling LXI Devices in *Section 4 Controlling LXI Devices with IVI Drivers*.

NOTE: If you experience issues when discovering LXI Devices, please refer to *Appendix A Troubleshooting*.

3.7.1 No need to Register LAN Devices with DHCP Server

You have determined that the DHCP Server on the company LAN does not require LAN Devices be registered in its database prior to issuing an IP Address. After having chosen a LAN Configuration, it is time to connect all devices according to that configuration and then find them with the **LXI Discovery Tool**. For the following discussion on finding LXI Devices, let us assume two configurations found in Figure 3.7: **Open System Configuration** (left) and **Isolated System Configuration Using Router** (right).

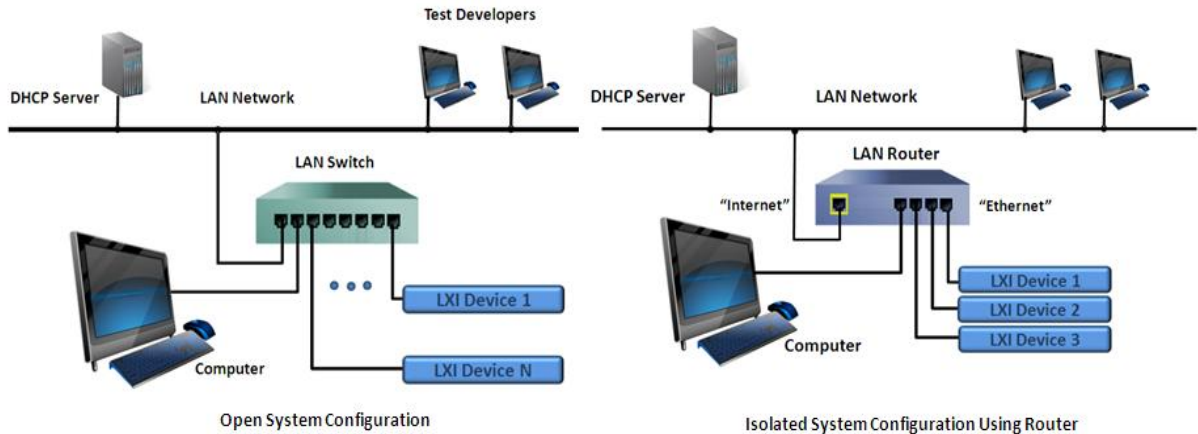

Figure 3.7 Open System Using Switch vs. Isolated System Using Router

Discover LXI Devices

The **LXI Discovery Tool**, found at [GuidesForUsingLXI](#), knows the protocols and services of LXI Devices and can discover them among other LAN Devices. Run the “**LXI_Discovery.exe**” program now and press the **Search** button to find LXI Devices.

The **LXI Discovery Tool** finds the IP Address of LXI Devices. Once found, as illustrated in Figure 3.8, you can bring up the LXI Device Web page by selecting the entry and clicking the **Open Web Page** button, or you can enter the IP Address into your Web Browser’s URL (Universal Resource Locator).

Note the IP Addresses of LXI Devices connected to the **Open System Configuration** in Figure 3.8 are in the range of **156.140.92.x**. This is a typical range of IP Addresses for a company LAN. This configuration will also permit the computer to see other LXI Devices on the company LAN and not just the ones connected to the LAN Switch. For some companies that have similar configurations on the LAN, the **LXI Discovery Tool** will discover many LXI Devices.

The **Isolated System Configuration Using Router** in Figure 3.8 has a built-in DHCP Server and defaults to using a private subnet range of IP Addresses **192.168.1.x**. The **LXI Discovery Tool** does not operate beyond the Router and only discovers the attached LXI Devices.

If you were running the **Isolated System Configuration Using Dual NIC Cards** with no software DHCP Server installed on **NIC #2**, IP Addresses would fall into the AutoIP range: **169.254.x.x**. The AutoIP mechanism takes place when LAN Devices find no DHCP Server. It is an automatic process for each LAN Device to assign itself an address and verify no other LAN Device is using that IP Address. It may take up to 2 minutes for LAN Devices to settle on a final IP Address. Most of that time is waiting to see if a DHCP Server responds.

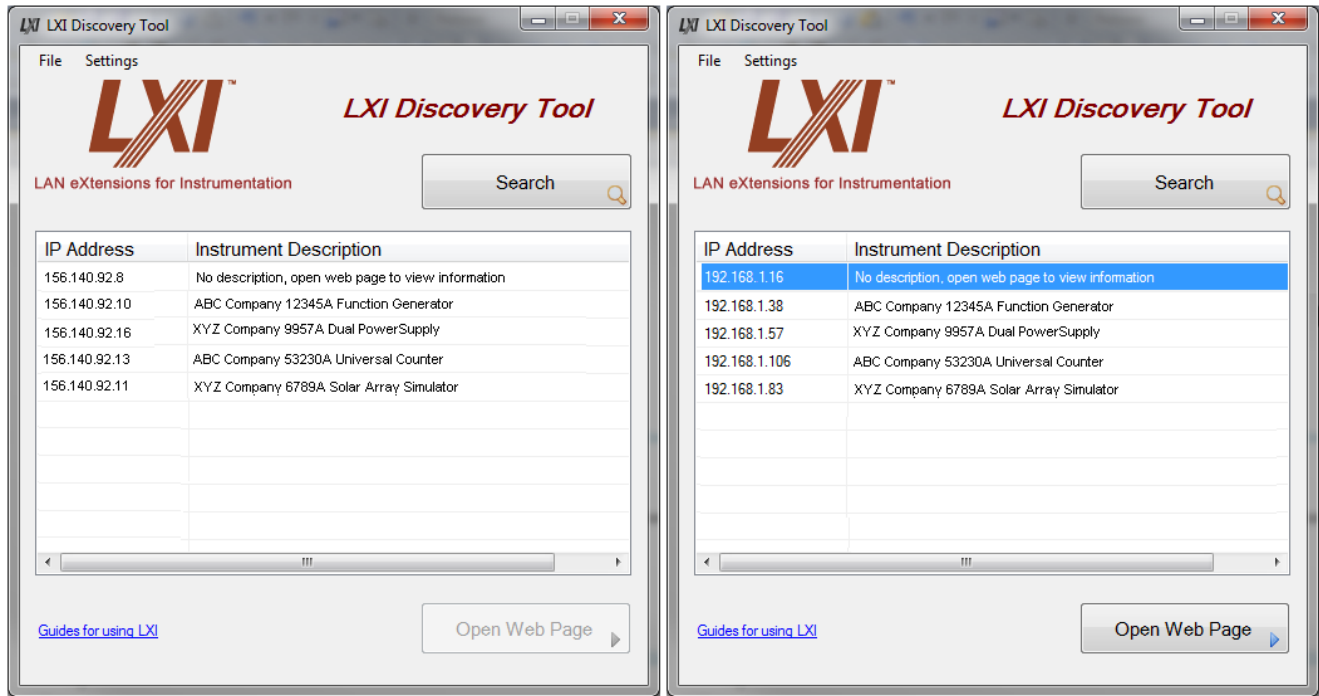

Figure 3.8 LXI Discovery on Open (left) vs. Isolated Router Configuration

The Home page must display the MAC Address and Hostname of the LXI Device. See Figure 3.9 for an example Home page of an LXI Device. The Hostname often derives from the Model Number and Serial Number, but you can change to something more meaningful in your Test System using the LAN Configuration page. The LXI Device in Figure 3.9 has a Hostname of “box”.

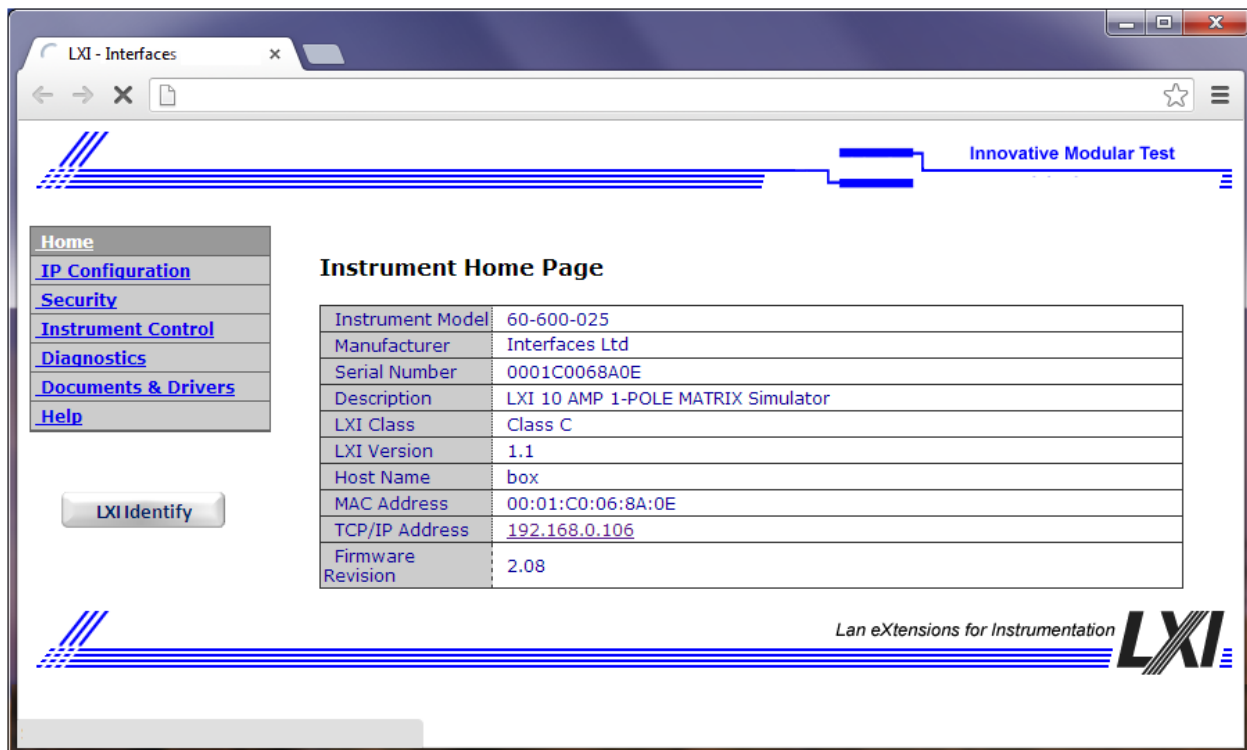

Figure 3.9 Example Home Page of an LXI Device

Associate Hostname with LXI Device through *LXI Identify*

Trying to associate a Hostname or IP Address among many LAN devices is challenging. However, LXI Devices support a function called LXI Identify. The Example LXI Device Home Page in Figure 3.9 shows a button called *LXI Identify*. Pressing this button will cause a visible indication on the Front Panel of the LXI Device. If the LXI Device has a display, a message like “Web Identify” could appear. If there is no Front Panel display, then a flashing LED or some other obvious indicator shows. You should create a label and place the Hostname of the LXI Device on its Front Panel for easy identification when controlling the device.

Now proceed to *Section 3.8 IP Address vs. Hostname* in preparation for *Section 4 Controlling LXI Devices with IVI Drivers*.

3.7.2 Must Register LAN Devices with DHCP Server

You have determined that LAN Devices require registration with the DHCP Server before adding them to the company LAN. Registration requires obtaining the MAC Address of each new LAN Device added to the DHCP Server's database. After having chosen a LAN Configuration, connect all devices, but do NOT connect the Switch, Router, or computer NIC #1 to the company LAN as illustrated in Figure 3.10.

You have now created a private subnet that does not involve the company LAN or the Network Administrator. This permits the *LXI Discovery Tool* to discover only the LXI Devices associated with this subnet.

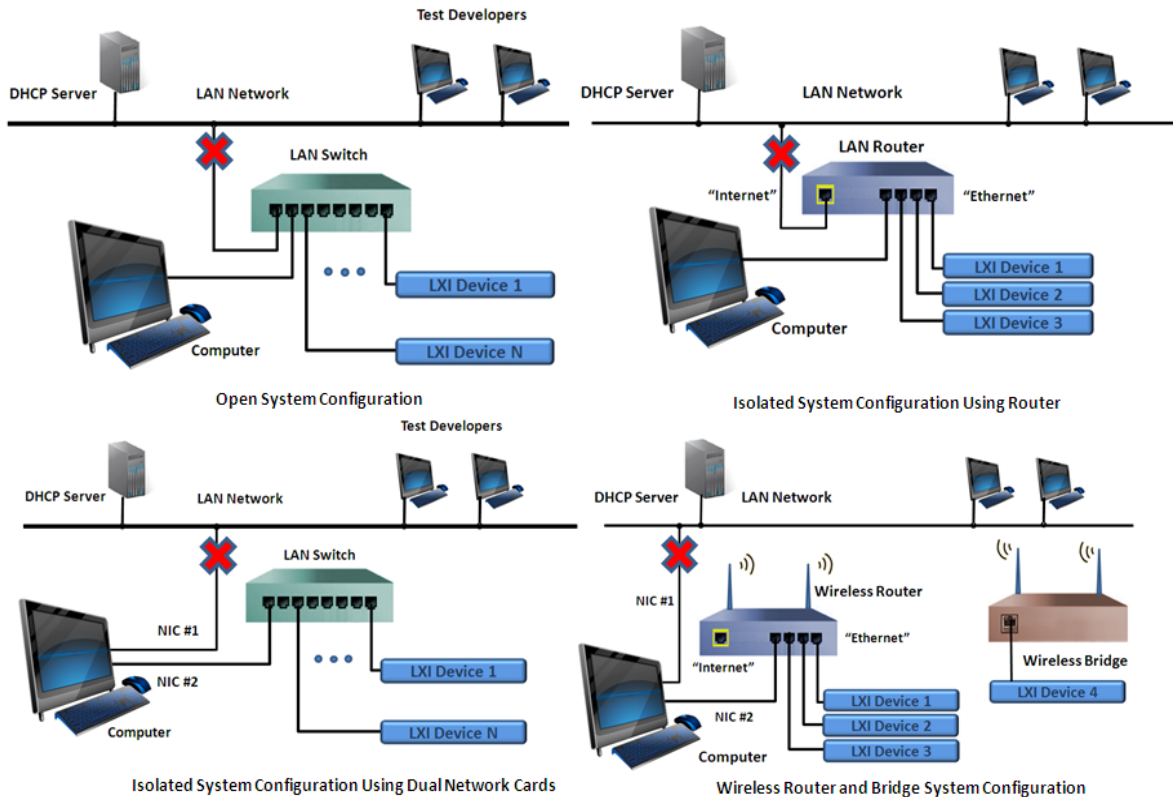

Figure 3.10 LXI Devices initially disconnected from company LAN

Discover LXI Devices on Private Subnet

The *LXI Discovery Tool*, found at GuidesForUsingLXI, knows the protocols and services of LXI Devices and can discover them among other LAN Devices. Run the "*LXI_Discovery.exe*" program now and press the *Search* button to find LXI Devices.

For the following discussion on finding LXI Devices, let us assume just two configurations found in Figure 3.10 - *Open System Configuration* and *Isolated System Configuration Using Router*.

The *LXI Discovery Tool* finds the IP Address of LXI Devices. Once found, as illustrated in Figure 3.11, you can bring up the LXI Device Web page by selecting an entry and then clicking the *Open Web Page* button, or you can enter the IP Address into your Web Browser's URL box (Universal Resource Locator). Note the IP Addresses of devices connected to the LAN Switch are in the range of **169.254.x.x**. This is the AutoIP address assignment when there is no DHCP Server. The Router has a built-in DHCP Server and defaults to using **192.168.1.x**.

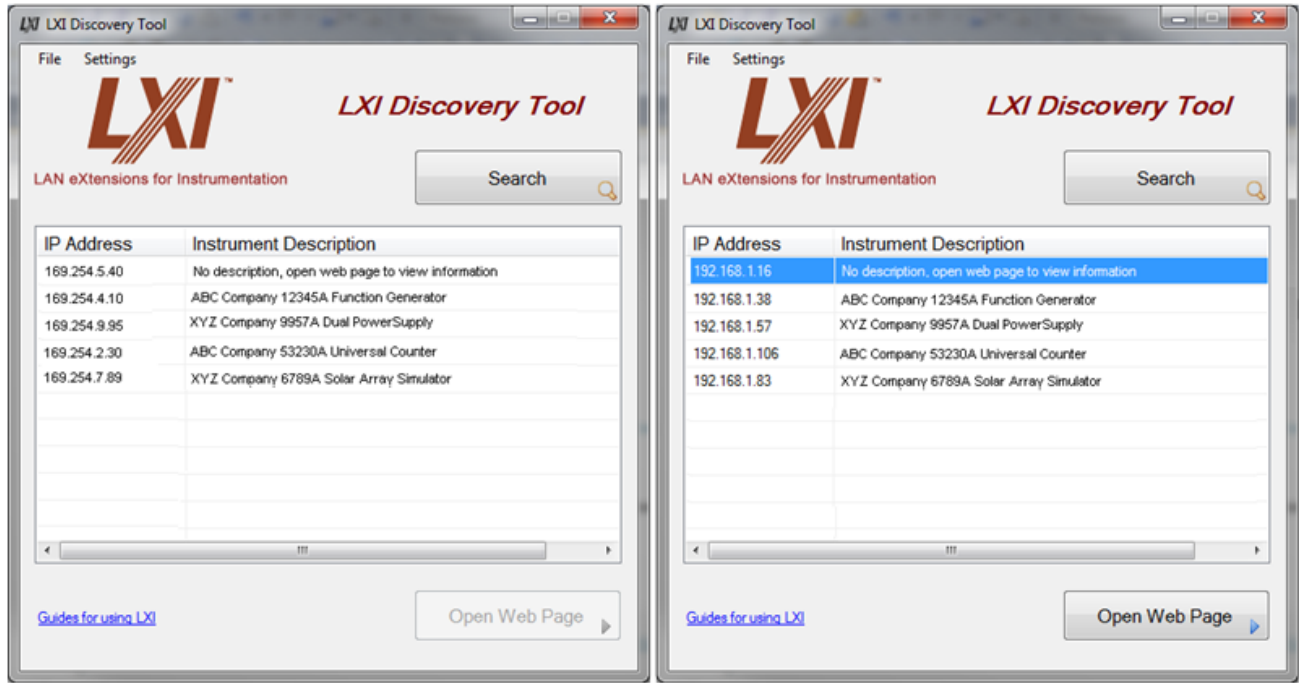

Figure 3.11 AutoIP and Router Discovery on Private Subnets

The Home page must display the MAC Address and Hostname of the LXI Device. See Figure 3.12 for an example Home Page of an LXI Device. The Hostname often derives from the Model Number and Serial Number, but you can change to something more meaningful in your Test System using the LAN Configuration page. The LXI Device in Figure 3.12 has a Hostname of “box”.

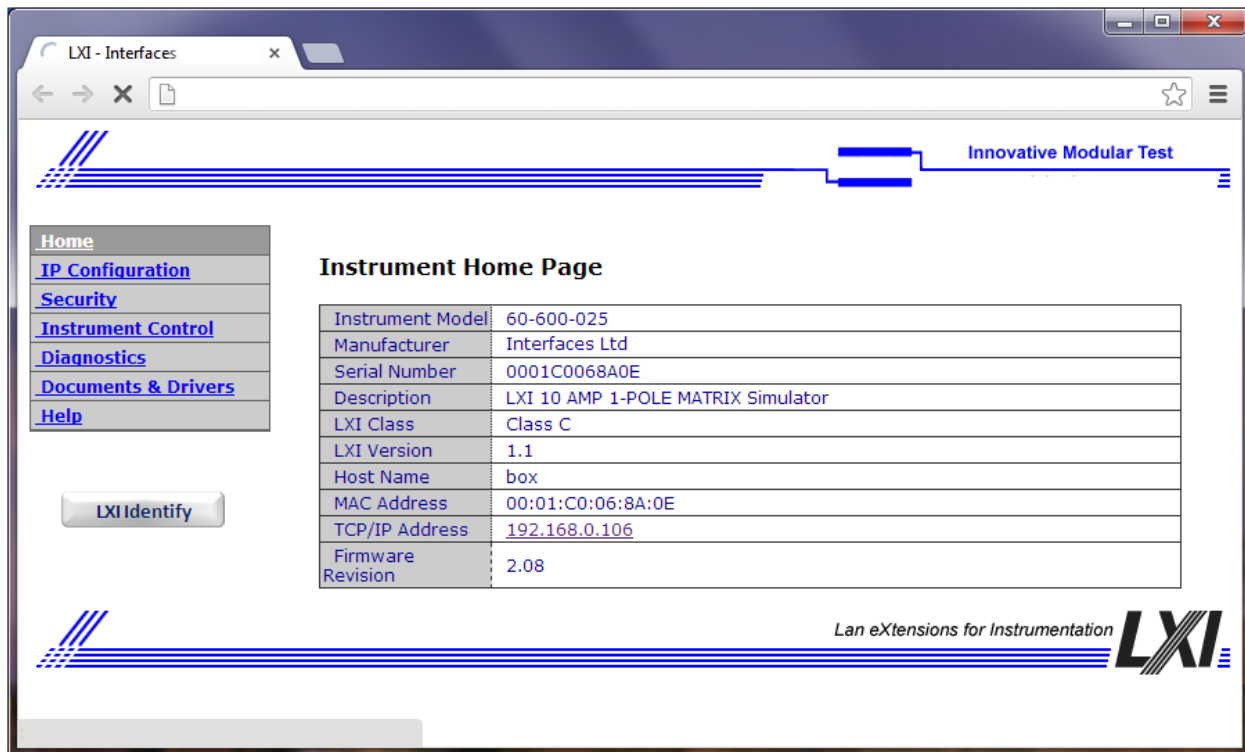

Figure 3.12 Example Home Page of LXI Device

Identify Hostname with LXI Device

Trying to associate a Hostname or IP Address among many LAN devices is difficult. However, LXI Devices support a function called *LXI Identify*. The Example LXI Device Home page in Figure 3.12 shows a button called *LXI Identify*. Pressing this button will cause a visible indication on the Front Panel of the LXI Device. If the LXI Device has a display, a message like “Web Identify” could appear. If there is no Front Panel display, then a flashing LED or some other obvious indicator shows. You should create a label and place the Hostname of the LXI Device on its Front Panel for easy identification when controlling the device.

Get the MAC Address of Other LAN Devices

If you are using a Router, you may need its MAC Address for connecting to the company LAN. As indicated earlier, the MAC Address for new LAN Devices will be required for companies whose DHCP Server only hands out IP Address to registered LAN Devices. *Appendix C. Routers and Dual NIC Features Explored* shows methods for a Router to clone the computer’s MAC Address, already registered with the DHCP Server. If MAC Address Cloning is not used, here are several methods for determining a Router’s MAC Address:

- MAC Address of Router found on manufacturer’s label near Serial Number
- Use “**arp -a**” from Windows Command prompt: to show IP Address to Physical Address of all visible devices. Referred to as Address Resolution Protocol:

```
C:\>arp -a
Interface: 192.168.5.2 --- 0x2
Internet Address      Physical Address      Type
192.168.5.1           00-90-fb-42-ff-0e    dynamic
...other devices
```

- Open up the Router’s Configuration and Status pages

For the Dual NIC configuration, use the Windows Command prompt and enter the following command “**ipconfig /all**”. This will result in a display similar to Figure 3.14 but with more LAN interfaces. “Physical Address” refers to the MAC Address.

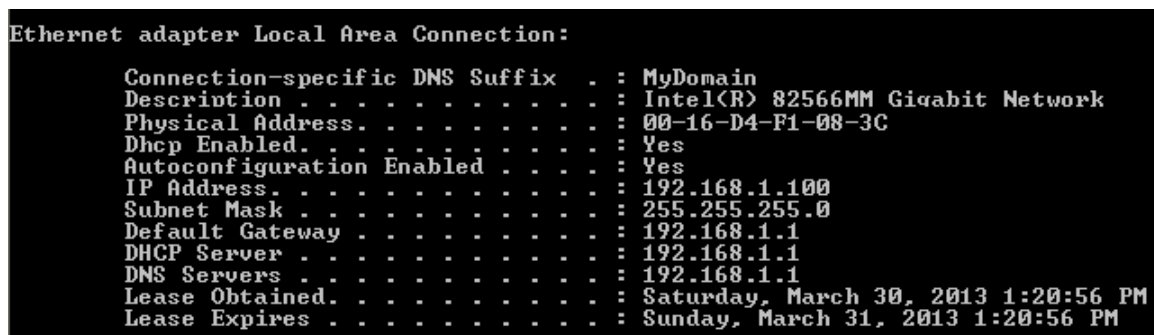

```
Ethernet adapter Local Area Connection:
Connection-specific DNS Suffix . : MyDomain
Description . . . . . : Intel(R) 82566MM Gigabit Network
Physical Address. . . . . : 00-16-D4-F1-08-3C
Dhcp Enabled. . . . . : Yes
Autoconfiguration Enabled . . . . : Yes
IP Address. . . . . : 192.168.1.100
Subnet Mask . . . . . : 255.255.255.0
Default Gateway . . . . . : 192.168.1.1
DHCP Server . . . . . : 192.168.1.1
DNS Servers . . . . . : 192.168.1.1
Lease Obtained. . . . . : Saturday, March 30, 2013 1:20:56 PM
Lease Expires . . . . . : Sunday, March 31, 2013 1:20:56 PM
```

Figure 3.14 Command Prompt in Windows showing LAN Interface Information

Since the second NIC interface connects to a private subnet and does not involve the company LAN, there is no need to register it with the Network Administrator. If not already done, you may have to register **NIC #1** with the Network Administrator, since it connects to the company LAN.

Reconnecting to the company LAN

Figure 3.15 now illustrates the four base configurations reconnected to the company LAN. The following discussion shows how the DHCP Server will react to the different configurations:

- **Open System Configuration** - LXI Devices 1-N acquire new IP Addresses if registered with DHCP Server
- **Isolated System Configuration Using Router** – LXI Devices retain same IP Address acquired from Router’s DHCP Server. If Router using MAC Addressing Cloning of computer, it will now re-appear on the company LAN and the DHCP Server will think the computer has returned. Otherwise, register the Router MAC Address with the DHCP Server.
- **Isolated System Configuration Using Dual Network Cards** – If using same NIC interface prior to new configuration, DHCP Server will think computer has returned. LXI Devices retain AutoIP addressing from non-DHCP Server NIC #2.
- **Wireless Router and Bridge Configuration** – If using same NIC interface prior to new configuration, DHCP Server will think computer has returned. LXI Devices retain same IP Address acquired from Router’s DHCP Server.

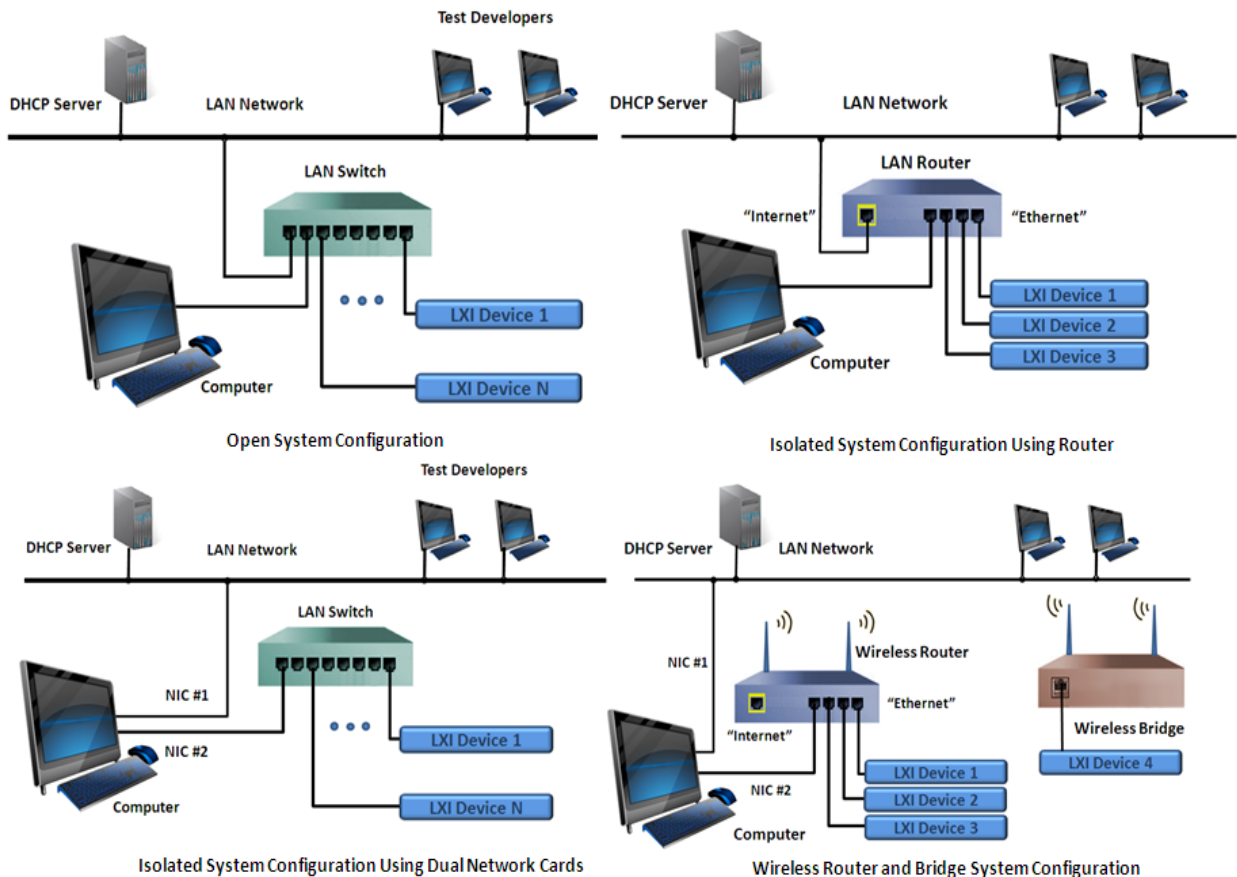

Figure 3.15 Base configurations re-connected to company LAN

In the upper left configuration of Figure 3.15, reconnecting the LAN Switch to the company LAN will require the LAN devices obtain new IP addresses from the DHCP Server. Since the computer and LXI Device acquired an AutoIP address without a DHCP Server, use the following steps to cause the devices to drop their AutoIP addresses and acquire new DHCP Server addresses when connecting to the company LAN:

- Disconnect the computer and LXI Device from the LAN Switch for 30 seconds, a time often required for LAN Devices to detect the LAN cable has been disconnected
- Connect the LAN Switch to the company LAN
- Reconnect the computer and LXI Device to the LAN Switch
- The DHCP Server will hand out new IP addresses to the computer and LXI Device

The *LXI Discovery Tool* can now search for any LXI Device that might be located on the company LAN.

Rediscovering LXI Devices

Re-run the “*LXI_Discovery.exe*” program again and press the Search button to find LXI Devices.

From a standpoint of IP Address assignment changes and the controlling of LXI Devices, the *Open System Configuration* (upper left of Figure 3.15) is the only configuration where the IP Addresses should change for the LXI Devices. In that configuration, the IP Addresses would have changed from AutoIP Addresses to DHCP Server IP Addresses associated with the subnet of the company LAN. For example, the addresses could have moved from the **169.254.x.x** to **156.140.95.x**, as seen in Figure 3.16.

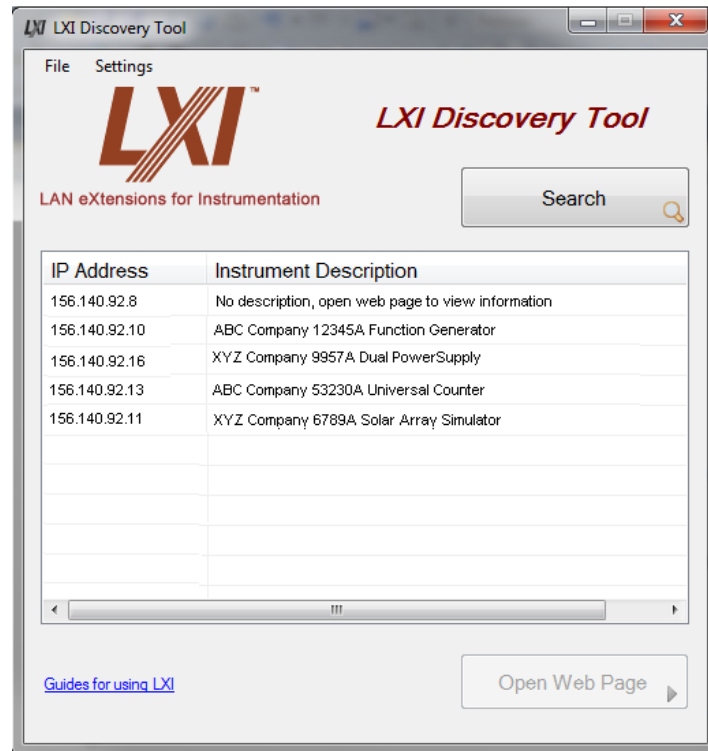

Figure 3.16 *Open System Configuration* connecting to company LAN

3.8 Using IP Address vs. Hostname

An IP Address is a number and difficult to associate with an LXI Device when programming. There are ways to create a human-readable name or Alias for that number in your program, but it is often better to begin with the Hostname. The Hostname remains with the instrument, wherever it goes, but the IP Address can change when moving from one subnet to another. The IP Address can also change when the DHCP Server on the company LAN is re-configured.

Figure 3.17 illustrates an example LAN Configuration page for an LXI Device. This page permits selecting the method of IP Address assignment for the LXI Device. LXI Devices permit Automatic IP Address or Static IP Address. With Automatic IP Address (DHCP and AutoIP), the LXI Device will first look for a DHCP Server, and if not found will assign itself an IP Address not currently used on its local subnet (usually in the range of **169.254.x.x**). When using Static IP Addressing, the user must make sure the IP Address selected is valid for the subnet in which this LXI Device operates. If you pick an IP Address already used on the local subnet, the LXI Device joining the network should move to a LAN Status fault condition and disengage. See more about this in *Appendix A Troubleshooting*.

The *LXI Discovery Tool* discovers the IP Address of each LXI Device. Opening the Home Page of each LXI Device reveals its Hostname. An LXI Device ships with a default Hostname often tied to the Model Number and Serial Number. This is closer to what you want rather than using an IP Address, but in cases where there are multiple devices with the same Model number, it would be better to use a descriptive Hostname. It is very common to have multiple power supplies in the Test System, and it would better to identify each specifically.

You can change the Hostname to anything, as long as it is a unique name and you use valid characters – letters, numbers, dash, and limited to 15 characters. After changing, the LXI Device retains that new Hostname even after cycling the power of the LXI Device. Each LXI Device’s documentation covers how to change the Hostname from the LAN Configuration page and/or Front Panel.

IP Configuration	
Hostname	box
Domain	DHCP server did not assign
Description	LXI 10 AMP 1-POLE MATRIX Simulator
Service Name	60-600-025 - 0001C0068A0E
<input type="button" value="Submit"/> <input type="button" value="Reset"/>	
TCP/IP Mode	<input checked="" type="checkbox"/> DHCP --> <input checked="" type="checkbox"/> Auto-IP --> <input checked="" type="checkbox"/> Manual
IP configuration sequence, at least one configuration must be selected	
IP Address	192 . 168 . 1 . 110
Subnet Mask	255 . 255 . 255 . 0
Default Gateway	192 . 168 . 1 . 254
DNS Server(s)	192 . 168 . 1 . 13 192 . 168 . 1 . 7
<input type="button" value="Submit"/> <input type="button" value="Reset"/>	

Figure 3.17 Example of LXI Device LAN Configuration

The Example LAN Configuration in Figure 3.17 illustrates a Hostname of “*box*”. All you need do is type in the desired name and hit the *Submit* button. If the chosen Hostname is not valid, an error message occurs. Once pressing the *Submit* button with a valid entry in the table, the LAN for the LXI Device restarts with the new Hostname, and the local Domain Name Server (DNS) saves the IP Address to Hostname re-assignment. The DHCP and DNS Servers are part of the company LAN and provide IP Addresses to DHCP Clients (LXI Devices and computers configured to ask for an IP Address when connecting to the company LAN) and Hostname resolution, respectively. The *Isolated System Configurations*, those hiding the LXI Devices behind a Router or on a second NIC interface, typically do not have a DNS Server. So how is that IP Address to Hostname resolution going to be resolved?

Absence of DNS Server in Isolated System Configurations

Network printers have been using a name resolution service called Bonjour for a long time. It is a service that runs on each network printer keeping track of printer Hostname and Service names as printers are connected and disconnected from the LAN. A computer running this service can access a printer by its Hostname, whether or not there is a DNS Server on the network. The Hostname is descriptive, but the Service name can be a long description – “Model ABCD Printer at post D7 in Building D”.

The LXI Consortium adopted the service called mDNS (Multicast DNS) beginning with the LXI 1.3 Standard, introduced in 2008. This service performs the Hostname to IP Address name resolution. When an mDNS client (LXI Device, computer, printer, etc.) needs to resolve a Hostname, it broadcasts a query message that asks the Host having that name to respond. That Host then multicasts (broadcast to a group of those listening) a message including its IP address. All devices in that subnet can then use that information to update their mDNS caches, containing the Hostname to IP Address association. The pseudo-level domain name “local” attaches to the Hostname, so “Hostname.local” is the designation used when accessing the LXI Device.

LXI Devices prior to the LXI 1.3 Standard may or may not have implemented such a service. Therefore, a computer without mDNS and a DNS Server must resort to storing the name resolution in its own Hostname resolution file. For example, Windows operating system computers use the file “hosts” located at “C:\WINDOWS\system32\drivers\etc”. Here is a portion of that file:

```
# This is a sample HOSTS file used by Microsoft TCP/IP for Windows.
#
# This file contains the mappings of IP addresses to host names. Each
# entry should be kept on an individual line. The IP address should
# be placed in the first column followed by the corresponding host name.
# The IP address and the host name should be separated by at least one
# space.
#
# For example:
#
# 102.54.94.97 rhino.acme.com # source server
# 38.25.63.10 x.acme.com # x client host

127.0.0.1 localhost
*
*
*
192.168.1.100 MyFavoriteDMM
```

You must have administrator privilege to edit this file. In the example above, the IP Address **192.168.1.100** is associated with *MyFavoriteDMM*. Rather than using the IP Address, you can now

use *MyFavoriteDMM*. If the LAN Configuration page of the LXI Device has assigned the same Hostname, then this device will be addressable using that Hostname when it returns to the company LAN, where the DNS Server will associate the new IP Address and Hostname.

The *LXI Discovery Tool* uses the mDNS service to find LXI Devices, so it installs with that tool. Other VISA Libraries install this service too and use a similar technique in discovering LXI Devices.

4 Controlling LXI Devices with IVI Drivers

This document illustrates using the IVI Driver approach to control LXI Devices. The IVI Driver is a required component for LXI conformance, so it will be available with every LXI Device. The IVI Driver presents a common programming interface for all LXI Devices, helping the programmer when dealing with different device types and from different vendors.

The following programming environments support the IVI Driver:

- Agilent VEE Pro®
- MathWorks MATLAB®
- Microsoft® Visual Studio C#, C++, and Visual Basic
- National Instruments LabVIEW® and LabWindows CVI

The IVI Foundation, www.ivifoundation.org, provides *IVI Getting Started Guides* for each of the mentioned programming environments. Those guides provide background information, installation instructions, and detailed examples. Each vendor typically supplies additional programming examples with the implementation of their IVI Driver. Please refer to the *IVI Getting Started Guides* for further information. .

Initializing the IVI Driver – using C# and VISA Library

```
// Create driver instances
driverFgen = new AbcCo.Abc3352x.Interop.Abc3352x();
driverDmm = new AbcCo.Abc344x.Interop.Abc344xx();
*
*
// Establish connection string - VISA Oriented
string resourceDescFgen = "TCPIP0::MyFavoriteFGEN::INSTR";
string resourceDescDmm = "TCPIP0::MyFavoriteDMM::INSTR";

string initOptions = "QueryInstrStatus=true, Simulate=false, DriverSetup= Model=, Trace=false";

bool idquery = true;
bool reset = true;

// Initialize the drivers...
driverFgen.Initialize(resourceDescFgen, idquery, reset, initOptions);
driverDmm.Initialize(resourceDescDmm, idquery, reset, initOptions);
```

Notice the *resourceDescFgen* and *resourceDescDmm* strings. The Hostname for each LXI Device inserts into the VISA Address String, or you can use the device's IP Address in that location. For IVI Drivers using the VISA Library, there are three principle VISA Address strings for LAN control:

- "TCPIP0::Hostname::INSTR" – VXI-11 protocol
- "TCPIP0::Hostname::hislip0::INSTR" – HiSLIP (High-Speed LAN Instrument Protocol)
- "TCPIP::Hostname::5025::SOCKET" – VISA LAN Socket protocol

VXI-11 and HiSLIP protocols provide an emulation of GPIB (General Purpose Interface Bus) to assist programmers migrating instruments from GPIB oriented test systems. The VISA LAN Socket represents a simple serial interface for communicating with an LXI Device. The number **5025** illustrated in the VISA Address string represents the port number for the Socket connection. The Home page of the LXI Device provides information on port numbers, whether the device supports HiSLIP, etc.

The flexibility of the VISA layer permits using the same code with varying protocols for the same LXI Device. VISA also provides a mechanism to represent the VISA Address string – the Alias. When discovering an LXI Device with the vendor’s VISA discovery tool, an Alias, or text-name, represents the formal VISA Address String and is changeable outside the source code of the test program. This Alias would have to be re-assigned when moving to a different computer whereas the program using the embedded VISA Address string with the Hostname would not.

Controlling LXI Devices – using C#

```
// Configure Function Generator output
driverFgen.OutputFunction.Function = Abc3352xOutputFunctionEnum.Abc3352xOutputFunctionSinusoid;
driverFgen.Output.Frequency = 10E5;
driverFgen.Output.Voltage.Amplitude = 5;

// Configure DMM for measurement
driverDmm.Trigger.TriggerSource = Abc344xTriggerSourceEnum.Abc344xTriggerSourceImmediate;
driverDmm.Trigger.SampleCount = 1;
driverDmm.Measurement.Initiate();
```

Notice the similarity in setting up LXI Devices. You need only type in the initialized driver variable followed by the “.”(Period), and the Visual Studio Intellisense determines the available functionality. For example, typing in **driverFgen** followed by “.” brings up the choices for that node, such as Output, which brings up Amplitude, Frequency, etc. If you are familiar with the operation of Function Generators, DMMs, Switches, etc., then you will know what you are looking for and find the features without the need for documentation.

IVI Common routine ErrorQuery() reads any errors generated by the particular LXI Device...

Common IVI Components – using C#

```
// Check for errors
int errorNum = -1;
string errorMsg = null;
while (errorNum != 0)
{
    driverFgen.Utility.ErrorQuery(ref errorNum, ref errorMsg);
    Console.WriteLine("\nFunction Generator ErrorQuery: {0}, {1}", errorNum, errorMsg);
}
errorNum = -1;
errorMsg = null;
while (errorNum != 0)
{
    driverDmm.Utility.ErrorQuery(ref errorNum, ref errorMsg);
    Console.WriteLine("\nDMM ErrorQuery: {0}, {1}", errorNum, errorMsg);
}
```

5 Test System Performance

The performance of a Test System is dependent upon many things. Some relate to the choice of LAN Configuration and the interconnecting LAN Devices such as Routers, Switches, Hubs, etc. but most relate to how you control the LXI Device. Unless you are very good with the native language or interface of the LXI Device, the IVI Drivers likely provides a faster development experience with good performance. It is important to identify the areas that affect Test System performance before making any changes.

Areas that Affect Test System Performance

- LAN Configuration – Open vs. Isolated, Wireless, VPN, Site-to-Site
- LAN Connection method – Sockets, HiSLIP, or VXI-11
- Transactional Latency vs. Block Transfers
- Measurement Setup and Speed

The first three are the focus of this document, but Measurement Setup and Speed can swamp any performance issues related to LAN. Here is a summary of each of these items:

LAN Configuration

The *Open System Configuration* exposes the computer and LXI Devices to LAN traffic. This LAN traffic can adversely affect performance and introduce variability in the test and measurement operations. The *Open System Configuration* may also allow unexpected operations like computer backups or virus protection, or operating system updates to the test computer, which also introduces variability in the test and measurement operations.

The only way to assure no interference to the computer and LXI Devices is to put them behind a Firewall. A Router provides such a Firewall, as illustrated in the *Isolated System Configuration Using Router*. However, once that happens, the Test System Administrator must keep the computer and other devices up-to-date with the latest software, since the Network Administrator has lost access to them. The *Isolated System Configuration Using Dual Network Cards* provides isolation for the LXI Devices and connecting network, but the computer can still experience interruptions as before, affecting Test System performance. See *Section 6 LAN Security* and *Appendix C Router and Dual NIC Features Explored*.

The *Wireless Router and Bridge System Configuration* runs into limitations of shared bandwidth. That is, additional wireless devices connected to the Wireless Router must share the wireless connection and will affect the LAN performance.

The two Remote configurations are oriented towards convenience and troubleshooting, so performance is not the primary focus. However, when using the VPN connection with the user outside the company intranet, it is best to remote-login to the Test System computer rather than trying to run tests from the remote computer. Running tests from remote computer is very slow and will likely cause timeouts and test failures.

LAN Connection Method

LAN can be very fast with 100Mbit or Gigabit interfaces, especially for block transfers of large amounts of data. Sending a large waveform to an Arbitrary Waveform Generator or reading back thousands or millions of readings from a Digitizer represent ideal applications for LAN. When using LAN, there are choices between connections, and the connections can provide varying performance. VXI-11 helps users migrate from GPIB Test Systems to LAN, and it emulates most of the GPIB functionality. The protocol used is not optimal and results in a significant performance difference

with Sockets. A Socket is a much a faster interface, but it only provides a simple serial interface for communication. The LXI Consortium and IVI Foundation have worked to overcome those limitations by creating HiSLIP (High Speed LAN Instrument Protocol). HiSLIP provides the emulation of GPIB using Sockets, so now you have the emulation of GPIB and a faster interface. Sockets and HiSLIP provide a 2-5 times faster interface than VXI-11. Note that not all LXI Devices support HiSLIP, since it introduced in 2011. Support listed on the LXI Device Home page.

Transactional Latency vs. Block Transfers

Many test programs move from sub-test to sub-test, and organize the flow of the program as **setup-measure-analyze**. The test program may consist of hundreds of such interactions. Many of the exchanges between the computer and the LXI Device are a small number of bytes, often representing the native language of the LXI Device. Many LXI Devices use a textual language like SCPI (Standard Commands for Programmable Instruments). The IVI Driver ultimately sends these commands to the LXI Device over the VISA interface. In contrast, some LXI Devices use a binary approach to controlling the LXI Device using their own interface library for communication.

100Mbit and Gigabit LAN interfaces have very high performance capability. However, LAN has a certain overhead in communication of data to and from devices, since the device or computer must read the entire packet before processing. Sending a single command (small number of bytes) and retrieving results (a single reading) – often referred to as “chatty” communication – results in time inefficiencies. Even when using a binary communication interface, short burst of data affects system performance. The LAN overhead is typically 200-300usec.

IVI Drivers may combine multiple operations to reduce the interactions with the LXI Device. If supported by the IVI Driver, state caching can keep track of the state of an LXI Device, or current configuration settings. When a user programmatically performs some operation to change the state of the instrument, the IVI Engine compares the desired state to the current state and determines which actual I/O commands need to send.

Some IVI Drivers do not provide state caching but keep track of the state of the LXI Device within the LXI Device. If the LXI Device uses an IVI Driver that eventually sends SCPI commands for each I/O transaction, it may be possible to improve performance by analyzing the commands sent by the IVI Driver and using VISA Library calls to send those commands as a block. For example, here is a short program listing using an IVI Driver:

```
// Configure Function Generator output
driverFgen.OutputFunction.Function = Abc3352xOutputFunctionEnum.Abc3352xOutputFunctionSinusoid;
driverFgen.Output.Frequency = 10E5;
driverFgen.Output.Voltage.Amplitude = 5;
```

The IVI Driver may send three SCPI commands in sequence using three separate LAN packets:

- Packet 1: “FUNC SINUSOID”
- Packet 2: “FREQ 10E5”
- Packet 3: “VOLT 5”

For LXI Devices using the VISA Library, there is usually a tool in the VISA Library to monitor I/O traffic. Step through the test program and watch the SCPI commands emitted to the LXI Device. If looking for ways to reduce LAN overhead, you could find such sequences in your program and convert them to a block of commands: “**FUNC SINUSOID ; FREQ 10E5 ; VOLT 5**” in one packet. Note the use of the “; :” between each command to permits multiple commands per line – often referred to as a compound command statement. For more information on sending and receiving data from LXI Devices using this technique, please refer to *Appendix D Other Methods for Controlling LXI Devices*.

Measurement Setup and Speed

We will not get into other aspects of Test System performance, but it is important to realize that many of the topics just covered could result in very little performance benefit due to the physics of the setup-measure sequence and the measurement time taking much longer than the communication time. For example, removing 60Hz noise from a signal requires measuring over the period of the noise signal (16.667 milliseconds). A Device-Under-Test (DUT) may take several hundred milliseconds to settle once configured for a test.

Performing as many operations in parallel as possible is always a good approach to reduce test time. For example, sending the setup commands to all devices in rapid succession allows for a single wait on the slowest device.

Studies have shown that many test applications require these large amounts of time for settling and measurements, which is the limiting factor in some test systems. That is, it may take 20 minutes to perform a test regardless of how fast your instruments can communicate.

There are many very good application notes, papers, etc. written by members of the LXI Consortium. When visiting an instrument manufacturer's Web site, use the following keywords and phrases in searching for more information on building test systems:

- Building a Test System or Building Automated Test Systems
- Test System Measurements
- Test System Design
- Guides to Test and Measurement

6 Test System Security

This guide is oriented towards a Test System attached to a company LAN and is, therefore, behind the company's Firewall. It also assumes a Test System added to the company LAN must adhere to company security standards. The various LAN Configurations recommended by this guide have various challenges with regard to company network security. Figure 6.1 is a summary of the first four recommended configurations. The two Remote configurations recommended are subsets of these four and are not illustrated.

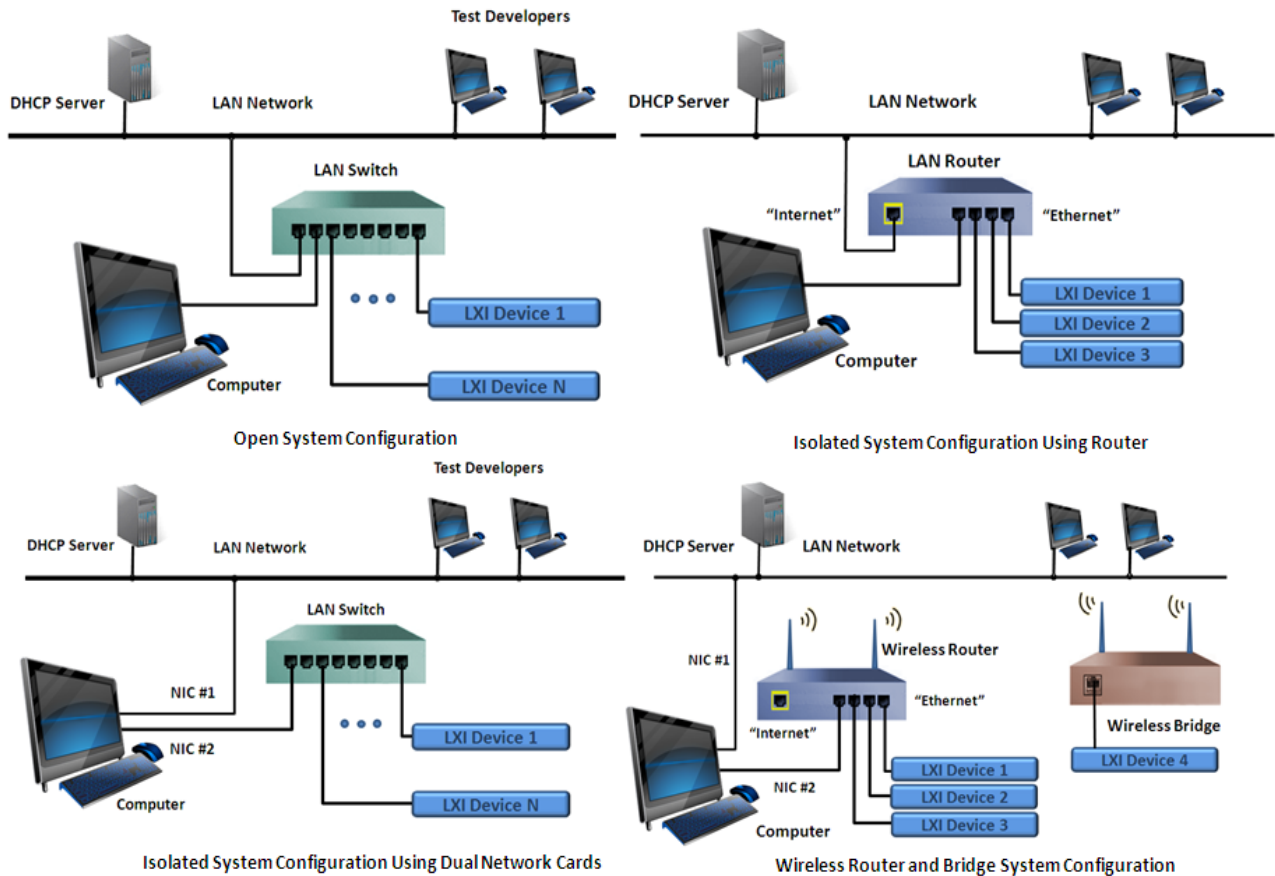

Figure 6.1 Recommended LAN Configurations

The following explains each configuration's potential challenge to company security standards. We begin with the assumption that the computer used in the Test System has already been equipped to meet company security standards and has approved access to the company LAN. Each recommended LAN Configuration then uses that pre-configured computer to build a Test System.

Most LXI Devices use an embedded operating system that does not pose a security threat since they do not access email or surf the Web. These same devices might support removable USB drives that could potentially infect the LXI Device if the embedded operating system allows running software on that USB device. However, these LXI Devices boot from a fixed, non-infected operating system image, so viruses are temporary.

There are some LXI Devices with embedded computers using commercial operating systems requiring virus protection software. These devices would be susceptible to the same security attacks as a company computer, except the devices typically would not be used for email or surfing the Web.

LXI Devices with these commercial operating systems often ship with Firewall protection enabled, and there should be recommendations provided for installing virus protection software to address security threats. In addition, many LXI Devices with USB Drives ship with Auto-run disabled when USB drives insert, and the installed virus protection software scans any inserted USB drives.

The LXI Consortium provides a document called *Malware Protection White Paper* under the IT Topics tab and found at <http://www.lxistandard.org/Resources/Default.aspx>. This paper gives examples of products with commercial operating systems requiring virus protection. Please refer to that document for further details on recommended methods of protecting such a device.

Open System Configuration

In this configuration, LXI Devices add to the company LAN using a LAN Switch, and the LAN Switch is simply extending the company LAN. LXI Devices with commercial operating systems requiring security software should have such software installed.

The Network Administrator should not push updates to an LXI Device even though it appears like a computer on the company LAN. The Test System Administrator should handle updates to the operating system, firmware, and virus software at a time when it does not affect Test System operation.

Security of the Test System also includes interruptions by outside users with access via the company LAN. Any user can access any LXI Device and cause existing test programs to fail. Coordinated use of the Test System is required in such cases. A DHCP Server reconfiguration could also change the IP Addresses of the LXI Devices and impact test operation. Using the Hostname for access avoids this problem, because the DNS Server will adjust the Hostname to IP Address changes.

Isolated System Configuration Using Router

In this configuration, the LXI Devices and computer are not accessible by the Network Administrator or other users, so no interruptions to test programs occur. This may be ideal for some applications where you never want to provide updates to a preconfigured computer and LXI Devices. Such computers typically have a memory image backup in case of disk drive or computer failure. LXI Devices may have older operating systems no longer providing updates, and some updates may affect device operation.

The computer and LXI Devices can pull updates through the Router using the Router's Gateway access, or the Test System Administrator can manually provide such updates. LXI Devices moved elsewhere may pick up a virus and when returned to the Test System and could infect other devices. Inserting USB drives may infect a device. A Test System computer accessing email or surfing the Web exposes itself to virus and worm attacks and requires security software installed.

There are methods of making the Test System computer "visible" through the Router, so the Network Administrator can maintain security. In essence, the Router can clone the MAC Address of the computer, allow anonymous requests (like Ping), and open specific ports in the Firewall to the computer IP Address on the isolated side ("Ethernet") of the Router. See *Appendix C Router and Dual NIC Features Explored*.

Isolated System Configuration Using Dual NIC Cards

In this configuration, the computer is accessible to the Network Administrator and other users, but the LXI Devices are not. Therefore, company security software pushes virus protection and operating system updates to the computer through **NIC #1**. These updates and backup operations should be coordinated with the Test System Administrator, to avoid test program interruption.

The Test System computer accessing email or surfing the Web exposes itself to virus and worm attacks and could infect LXI Devices. LXI Devices removed and returned to Test System could infect other devices. Devices infected by insertion of USB drives need protection. LXI Devices on **NIC #2** subnet can infect the computer if they were infected. LXI Devices with commercial operating systems need virus software protection. Pulled updates to virus protection can occur by enabling Internet Connection Sharing (ICS) between **NIC #1** and **NIC #2**. See *Appendix C Router and Dual NIC Features Explored*.

Wireless Router and Bridge Configuration

This configuration is the same as the *Isolated System Configuration Using Dual NIC Cards*, except it adds the Wireless Router and Bridge, which introduces additional security issues. For example, wireless access could expose the LXI Device and test computer to unwanted connections or interrupts by others with access to the wireless signal. This configuration would require Network Administrator approval and additional security due to exposing the wireless signal to the outside world. This LAN Configuration offers three aspects that help maintain security:

- Dual NIC creates Firewall between company LAN (**NIC #1**) and Wireless Router (**NIC #2**)
- Wireless Router can use WPA2 (Wireless Protected Access) offering strong wireless security
- Service Set Identifier (SSID) hiding

To improve security, do not enable Internet Connection Sharing when the Wireless Router is broadcasting. That is, all devices on Router subnet remain disconnected from Internet.

SSID hiding provides security from casual users and only hides the identification of the wireless signal. A Wireless Scanner can still detect the signal and provide a knowledgeable user access to the signal.

WPA2, with 128-bit encryption of the password, can stop unwanted access. However, users who know the password can cause interruptions to the test system.

Appendix A. Troubleshooting

This appendix mostly provides insight into problems during the *Discovery* process discussed in *Section 3*. It also reaffirms the need to talk to your Network Administrator if you cannot acquire an IP Address when connecting to the company LAN. The problems found assume a connection oriented problem and not due to failures of the LXI Device's hardware, although diagnosing hardware failures may follow these same suggestions. The following are the key problems covered in this appendix:

- LAN Status Fault indication shown on LXI Device
- Cannot Discover LXI Device with *LXI Discovery Tool*
- No IP Address when reconnecting to the company LAN
- *LXI Discovery Tool* finds the LXI Device, but you can't access its Web page

The *LAN Status Fault Indication on LXI Device* condition may be common to other problems, so references back to this condition will occur often.

LAN Status Fault Indication on LXI Device

A LAN Status Fault indication represents a condition where the LXI Device has not acquired an IP Address. Figure A.1 illustrates three examples from various LXI Devices where the LAN Status indicates a fault condition. The top two lines in the Figure A.1 are an excerpt from the Front Panel display of an instrument, typically found under the Utility or System keys. Notice the combination of an IP Address of **0.0.0.0** and the Red LAN Status word **Fault**. The lower example in Figure A.1 is a monochrome display, and its LAN Status Fault condition is an IP Address of **0.0.0.0** and an asterisk (*). The example in the middle has no display, so it sets its LAN Status indicator to Red indicating the fault condition.

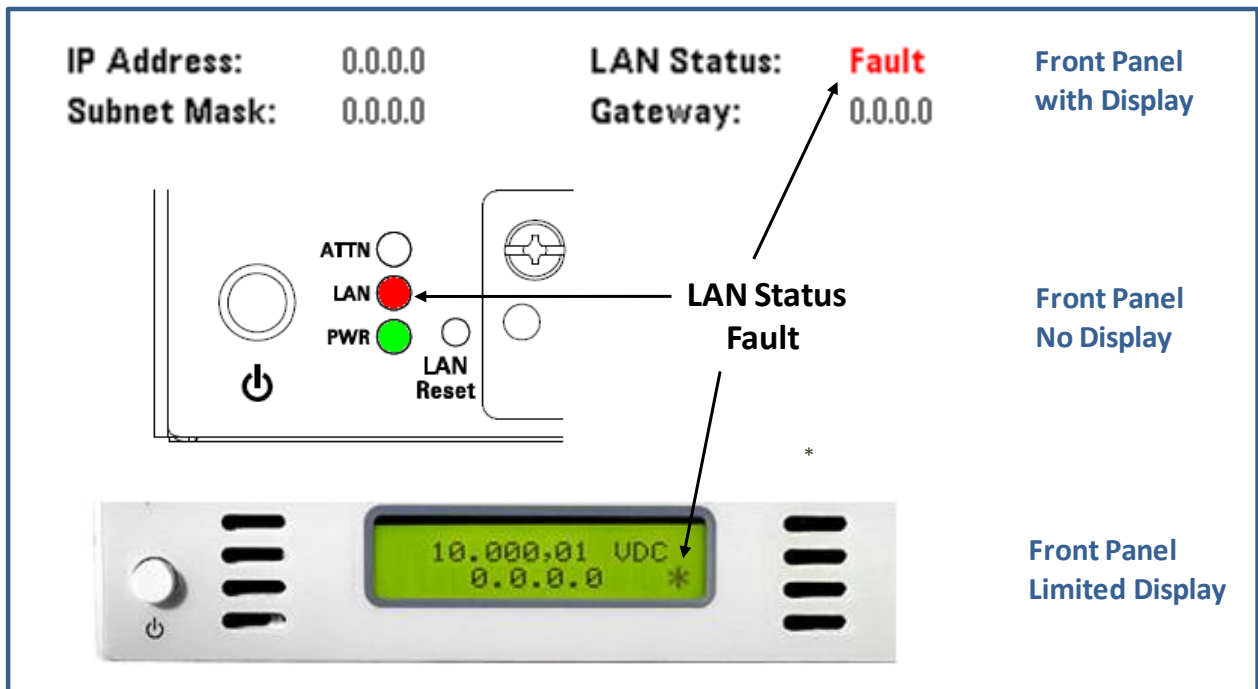

Figure A.1 LAN Status Fault Examples

The following are likely causes of the LAN Status Fault:

- The LAN Cable is bad or disconnected from the LXI Device.
 - Verify the LAN cable completely inserts into the RJ45 Connectors of the LAN Switch and LXI Device. Make sure it clicks when inserted indicating it has locked into place.
 - Verify the LAN cable is not defective by trying a different cable or using the suspected cable in a known good configuration.
- The Switch or Router is OFF.
- The LXI Device tried to use an IP Address of another LXI Device on the subnet. This is a duplicate IP Address error, so the LXI Device disconnects itself from the LAN.
- The DHCP Server issues an IP Address for a limited time – called the Lease Time. If the DHCP Server is no longer available to renew the lease, the LXI Device will move to the AutoIP mode (**169.254.x.x**) and assert the LAN Status Fault indicator showing it has changed IP Addresses. This is not likely to happen and especially not after power-ON, because lease times are typically 24 hours.

Check the first two conditions and cycle power on the LXI Device. If the problem persists, it is likely the LXI Device has a Static IP Address already in use by another LAN Device connected to the Switch or Router and created a Duplicate IP Address error condition. The LCI (LAN Configuration Initialize) or LAN Reset mechanism resolves this type of problem.

An LCI resets the LXI Device to DHCP Addressing Mode, resets Web page password to its default documented setting, and re-enables the mDNS (Multicast Domain Name Service) discovery mechanism. LXI Devices with LXI 1.3 Standard and above have the mDNS discovery mechanism.

The LCI mechanism is a recessed button on the LXI Device or is a softkey in a menu, usually under the Utility or System keys. Figure A.2 illustrates an instrument with the LCI mechanism on both the front and rear of the LXI Device. LCI and LAN Reset are common labels on LXI Devices and refer to the same operation. Reaching the LCI button may require using a paper clip. The LXI Device will then restart its LAN and attempt to acquire an automatic IP address. Allow 30 seconds for the restart process and then run the *LXI Discovery Tool* again.

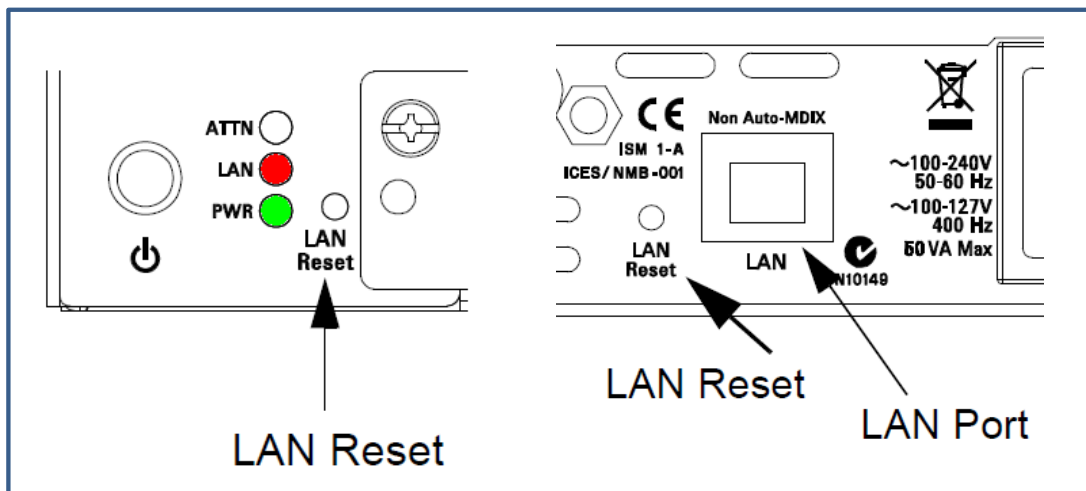

Figure A.2 LAN Reset (LCI mechanism)

Cannot Discover LXI Device with *LXI Discovery Tool*

You have performed the Search with the *LXI Discovery Tool* but found no LXI Device. If there is an entry in the table that says “No description, open web page to view information”, then select the entry and press the *Open Web Page* button to verify this unidentified device is the one you want.

If the table is empty after searching, then there is a problem in discovering the LXI Device’s IP Address. Check the LXI Device’s LAN Status to see if it has a LAN Status Fault condition. If so, follow the directions given in the first problem case, *LAN Fault shown on LXI Device*.

If there is no LAN Status Fault indication on the LXI Device, then it is possible the LXI Device has a Static IP Address that is valid but not reachable by the computer – not in the same subnet. Perform the LCI or LAN Reset as described in the previous problem case, *LAN Status Fault shown on LXI Device*. Since there is no Duplicate IP Address and thus a no LAN Status Fault, performing the LCI will reconfigure the LXI Device into the same subnet as the computer.

One other possibility is the computer’s IP Address. If the computer has a static IP Address not mapping to the same subnet as the LXI Device, then configure the computer to either use DHCP, or a static IP Address and subnet mask matching the subnet of the LXI Device. Configuring your computer’s IP Address is beyond the scope of this document and varies widely between operating systems. Please ask your Network Administrator for help in this situation.

No IP Address when connecting to the company LAN

If the LXI Device is not found or its IP Address falls into the **169.254.x.x** range when connecting to the company LAN, then it is likely due to the DHCP server not allowing new LAN devices without first registering them with the DHCP Server. The problem could also be the need for a Static IP Address assignment to the LAN Device. In both of these cases, you need to talk to your Network Administrator to resolve the situation. Come prepared with the MAC address of the LXI Device, so he can add it to the DHCP Server’s configuration table. Follow the MAC address discovery process described in *Section 3*.

LXI Discovery Tool finds the LXI Device, but you can’t access the Web page

This is likely to happen only with LXI Devices with mDNS discovery. The LXI Standard requires mDNS discovery since version 1.3. However, some LXI Devices incorporated this mechanism prior the requirement in the LXI Standard. In this situation, the mDNS discovery mechanism has discovered the LXI Device, but its IP Address does not match the subnet of the computer.

To resolve this condition, activate the LCI mechanism, as described in the problem scenario *LAN Status Fault Indication on LXI Device*. This should force the LXI Device’s IP Address into the same subnet as the computer.

If this does not clear up the problem, then the computer running the *LXI Discovery Tool* has a static IP Address not mapping to the same subnet as the LXI Device. Configure the computer to either use DHCP, or a static IP Address and subnet mask matching the subnet of the LXI Device. Configuring your computer’s IP Address is beyond the scope of this document and varies widely between operating systems. Please ask your Network Administrator for help in this situation.

Appendix B. Router and Dual NIC Features Explored

Please note that any suggestions related to configuring Network interfaces or Routers *should be coordinated with your Network Administrator*. The Network Administrator can recommend Network interface cards, Routers, and configurations that work best in your company environment. Use this section to assist in understanding and planning the Test System configuration.

The *Isolated System Configuration Using Router* and *Isolated System Configuration Using Dual Network Cards* have certain issues you may want to resolve for particular requirements. The list below offers some cases for consideration:

- Accessing Test System Computer on Isolated side of Router
- Internet Connection Sharing (ICS) between Dual Network Interfaces

The following summarizes the Dual NIC Card and Router configurations.

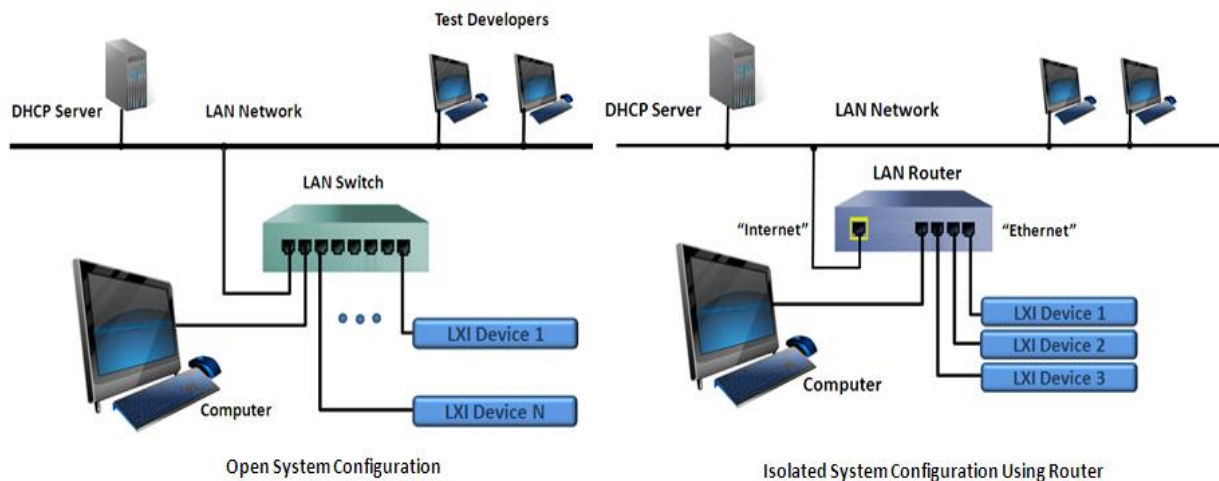

Figure B.1 Isolated System Configurations – Dual NIC (left) and Router (right)

Dual NIC Configuration

The Dual NIC configuration requires two network interfaces. Every modern computer has at least one built-in network interface. A second interface installs in the computer by opening its case and inserting a Network Interface Card into an available slot, or the second interface could be a USB-to-Network module that plugs into an available USB port. If the computer is equipped with wireless, the wireless connection could connect to the company LAN through the company wireless Router, and the built-in network interface can connect to the LXI Devices.

The configuration in Figure B.1 shows a LAN Switch connected to **NIC #2**. IP Addresses for this configuration are typically static and configured by the Test System Administrator. The LAN Configuration for each LXI Device and **NIC #2** provides the means to assign static IP Addresses. If you leave the computer and LXI Devices configured for DHCP, the AutoIP configuration process will assign addresses in the range of **169.254.x.x** if no DHCP Server found. AutoIP can take up to two minutes to resolve IP Addresses for the computer and LXI Devices. When using static IP Addresses, Test System Administrators typically assign the **169.254.1.1**, **169.254.1.2**, etc. addresses to LXI Devices and the computer.

The computer has access to the Internet through the company LAN (**NIC #1**). The LXI Devices do not, unless you enable Bridging or Internet Connection Sharing (ICS) between the two network interfaces.

Bridging would essentially create the *Open System Configuration*, where all traffic on the company LAN **NIC #1** passes to **NIC #2**. This is not what you want. ICS enables only Client access to the Internet on **NIC #2**. That is, LXI Devices can access the company LAN via the Gateway, which is the **NIC #1** interface. The company LAN cannot access the LXI Devices, because the test computer creates a Firewall between the two network interfaces.

With ICS enabled, the computer provides Network Address Translation between **NIC #2** and **NIC #1**. All Client requests to the Internet appear to be coming from the **NIC #1** interface IP Address. ICS also provides DHCP for **NIC #2**, so you do not have to assign static IP Addresses to each of the LXI Devices.

Router Configuration

The computer and LXI Devices connect to the “Ethernet” side of the Router, and the Router connects to the company LAN through the WAN or “Internet” connector. The Router picks up its IP Address from the company LAN DHCP Server. The computer and LXI Devices pick up their IP Addresses from the built-in DHCP Server of the Router, which connect through the 4-8 port Switch built into the Router.

The WAN or “Internet” Address is on a different subnet from the “Ethernet” side, otherwise the Router will probably not acquire an IP Address from the company LAN. Router DHCP Servers default to using **192.168.1.x** when assigning IP Addresses. Two default-configuration Routers connected in series would create a WAN and “Ethernet” subnet using the same IP Address range (**192.168.1.x**), and would not work properly.

Routers configuration pages are on the “Ethernet” side and typically use the IP Address **192.168.1.1** or **192.168.0.1**. This address becomes the Gateway for the LXI Devices that wish to connect to the Internet. Security to protect access to the Router configuration page is defaulted from the factory, and often has a login of “admin” and a password of “password”, or some similar combination, as discussed in the Router’s User Guide. A recessed reset button on the bottom or rear of the Router clears any previous security settings to the factory defaults, when you press and hold it down for 10 seconds.

Routers have a default Firewall configuration to isolate the “Ethernet” side from direct access of the WAN or “Internet” side. However, Port Forwarding or DMZ (De-Militarized Zone) overrides this isolation and provides for a device on the “Ethernet” side to respond to the “Internet” side requests.

Accessing Test System Computer on Isolated side of Router

Routers can create a new subnet isolated from the company LAN subnet. A Router’s Firewall creates a barrier that blocks anonymous requests and LAN port access from any device to the “Ethernet” side. The purpose of putting the computer and LXI Devices together on the “Ethernet” side is to keep other users from interrupting test programs. However, this also blocks Network Administration software and keeps potential users from remote-login to the Test System computer for development - two capabilities you may actually need.

There are two methods for accessing devices on the isolated side of a Router: Port Forwarding and using the DMZ. Host-to-Host communication typically uses a combination of the IP Address and Port number. The only IP Address seen from the company LAN is the Router’s WAN or “Internet” IP Address. Requests to this IP Address are blocked or filtered from passing on to the “Ethernet” side. Port Forwarding allows a particular port or port range assignment to a specific IP Address on the “Ethernet” side. DMZ opens all ports to a single IP Address.

Port Forwarding is more secure since only the ports you want to allow are passed on to the “Ethernet” side. However, for this Test System configuration, you want to permit the computer to reclaim the access it

already had when connected directly to the company LAN. Therefore, using the DMZ approach is simpler than using Port Forwarding.

Some Routers require the device in the DMZ use an IP Address on a different subnet from the other devices, and they require the device connection to a specific RJ45 connector. This is great for isolating the exposed device from the other devices, but the requirements for the Test System is the computer connects to the same subnet as the LXI Devices. If that is the case, you will have to use the Port Forwarding approach and allow all ports from 0 to 65535 to pass to the “Ethernet” side.

Here are the steps to making the computer visible again to the company LAN. Your Router configuration may vary in terminology, but the concepts are the same.

- **Clone the MAC address of the computer** – Routers come with a unique MAC Address, but you can replace it with the computer’s MAC. The company LAN DHCP Server will then think your computer still connects directly to the network and will assign the Router an IP Address.
- **Allow Network Administrator software to Ping computer** – Disable a feature typically called “Filter anonymous internal requests”, which would block Ping, a method to see if your computer is responding. Ping is not a TCP/IP Port-oriented request but uses a protocol called ICMP (Internet Control Message Protocol).
- **Enable the DMZ** – Use the IP Address assigned to your computer on the “Ethernet” side as the Destination. Choose to allow any Source IP Address to access the Router, or you can pick an “allow” list of consecutive IP Addresses access to the DMZ device. DMZ forwards all ports.
- **If DMZ cannot be used, use Range Port Forwarding** – Use the IP Address assigned to your computer on the “Ethernet” side as the “To IP Address” and open up the entire range of ports from 0 to 65535 to mimic DMZ, or only pass those ports needed by IT for configuration management, security updates, backups, or remote-login access. The Network Administrator can help with this information.

Internet Connection Sharing between Dual Network Interfaces

The Dual NIC configuration creates an isolation barrier between **NIC #1** and **NIC #2**. Your computer already has access to the Internet through **NIC #1**. Devices on **NIC #2** do not have access and cannot perform firmware, software, or virus definition updates.

Bridging would allow all traffic from **NIC #1** to **NIC #2**, and would remove the isolation created with the second NIC. Internet Connection Sharing (ICS), however, would allow LXI Devices access to the Internet again by using **NIC #2** as the Gateway and Network Address Translation (NAT) as the method of hiding the isolated subnet’s IP Addresses.

For the following steps, assume **NIC #1** – Local Area Connection and **NIC #2** – Local Area Connection 2 when viewing in Figure C.2. These steps assume Windows XP but are similar for newer versions of Windows:

On the Test System computer, follow these steps to share the Internet connection on **NIC #1**:

1. Login to the computer as Administrator or as Owner.
2. Click **Start**, and then click **Control Panel**.
3. Click **Network and Internet Connections**.
4. Click **Network Connections**.
5. Right-click the connection used for connecting to the Internet (**NIC #1**).
6. Click **Properties**.
7. Click the **Advanced** tab.
8. Under **Internet Connection Sharing**, select the **Allow other network users to connect through this computer's Internet connection** check box.

9. Select **NIC #2** as the Home Networking Connection
10. Click **OK**.

When Internet Connection Sharing enables, **NIC #2** will be set to use IP Address **192.168.0.1** and a subnet of **255.255.255.0**. The ICS connection will automatically forward TCP/IP requests from **NIC #2** to the Gateway of **NIC #1**. Network Address Translation (NAT) also takes place on requests from **NIC #2**. DHCP addressing is set up for devices that connect through **NIC #2**, and the Gateway those devices are assigned is **192.168.0.1**. Figure B.2 also shows the result of an “ipconfig”, which reveals the connection information for both LAN interfaces.

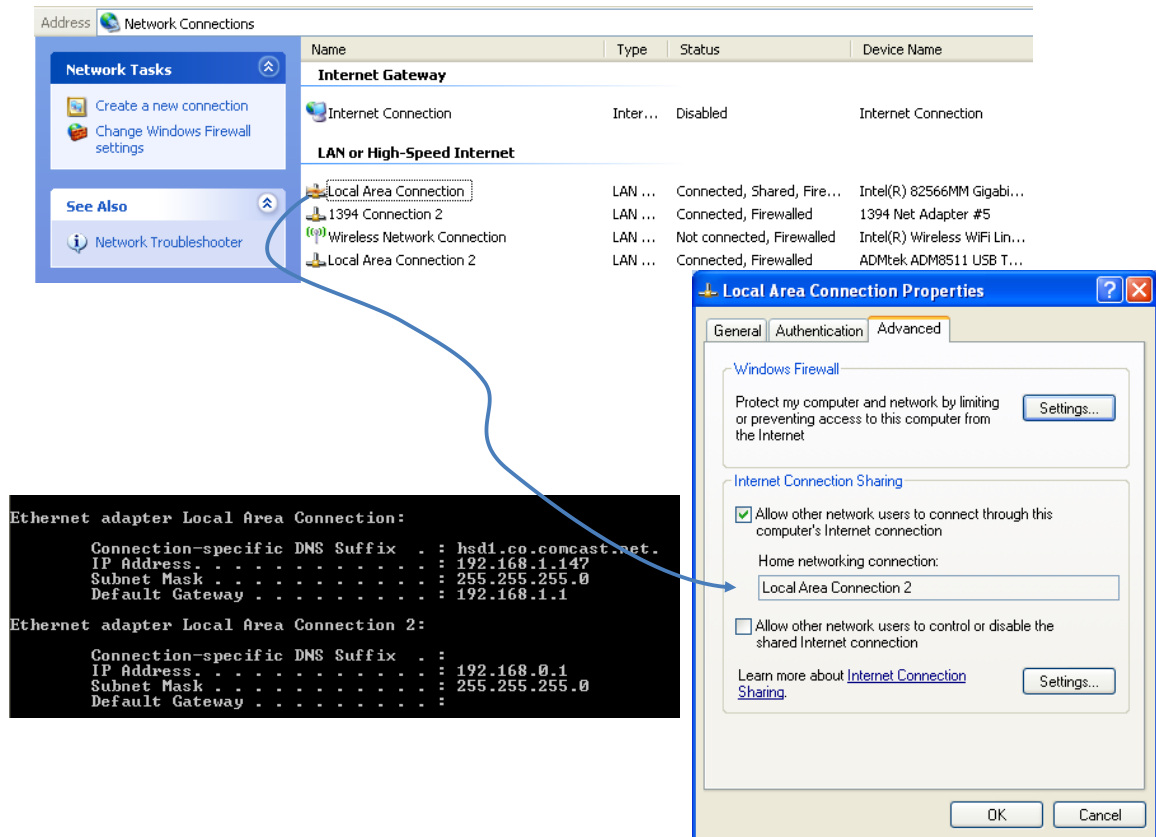

Figure B.2 Setting Up Internet Connection Sharing

Appendix C. Other Methods of Controlling LXI Devices

The focus of examples in this document has been using the IVI Driver to control LXI Devices. The IVI Driver provides a common interface between LXI Devices and shields you from the specific command language (native language) used in various LXI Devices. A concept called Native Driver also exists for software such as NI's LabVIEW or MathWorks MATLAB, where developers write a specific driver using the LXI Device's command language. This gains the benefit of creating a driver interface that is well adapted for the particular Application Software.

If the Application Software does not use a driver to control the LXI Device, the terminology Direct I/O applies. Instead of interfacing with an API (Application Programming Interface), the LXI Device's command language embeds directly into the source code of the Application Software.

Figure C.1 illustrates a summary view of using the IVI Driver or Direct I/O. The IVI Driver can communicate through VISA or other vendor-supplied interface software. Replace the Application Software with NI LabVIEW, and the IVI Driver box with an NI LabVIEW driver, and you have another method of driver control. Place the LXI Device command language directly into the source code of the Application Software and interface through VISA, the Client Side API, or the Socket, and you have Direct I/O control.

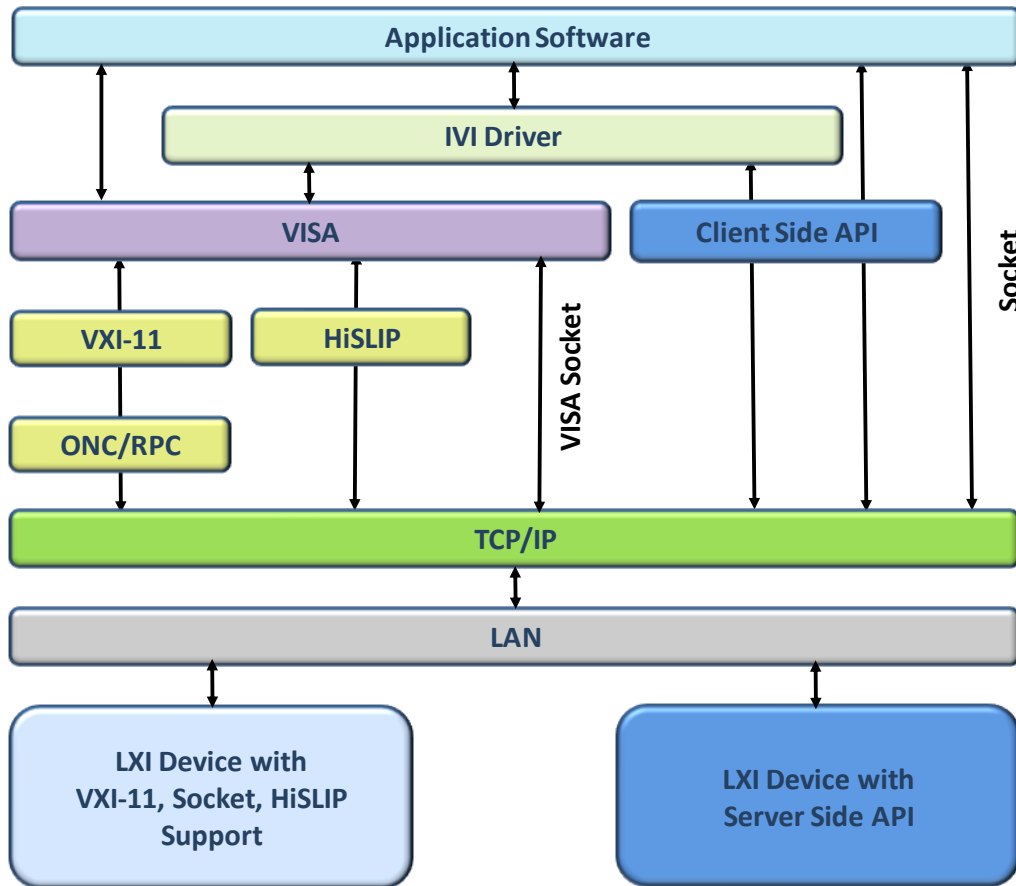

Figure C.1 Summary view of interfaces to LXI Devices

C# Example Using Direct I/O and SCPI to Control LXI Devices

Many prefer to embed the LXI Device command language into their Application Software. Drivers do not necessarily provide all functionality of the LXI Device, and Users may want access to all features and at the lowest level of control. To do this, one must learn the LXI Device's command language. Vendors often supply Direct I/O example programs in the same programming environments supporting IVI Drivers – Microsoft Visual Studio C#, C++, Visual Basic, etc. Sometimes programmers use the IVI Driver for the most common control features and take a hybrid approach by also embedding SCPI commands into their Application Software when it is necessary to access a particular device feature.

Most Direct I/O utilizes the VISA interface layer to access the LXI Device and sends SCPI language commands. The following is a C# Console application program example illustrating how to send SCPI commands to a Function Generator using VISA COM 3.0 Library (Common Object Model). VISA COM provides access to multiple programming choices, such as C#, C++, Visual Basic, etc.

- Install desired vendor VISA Library
- Using Visual Studio, create a new project for Visual C#
- Specify the project as a Console Application
- Name the application ConsoleVISAexample
- Add to the References the VISA COM 3.0 Library, according to Figure D.2

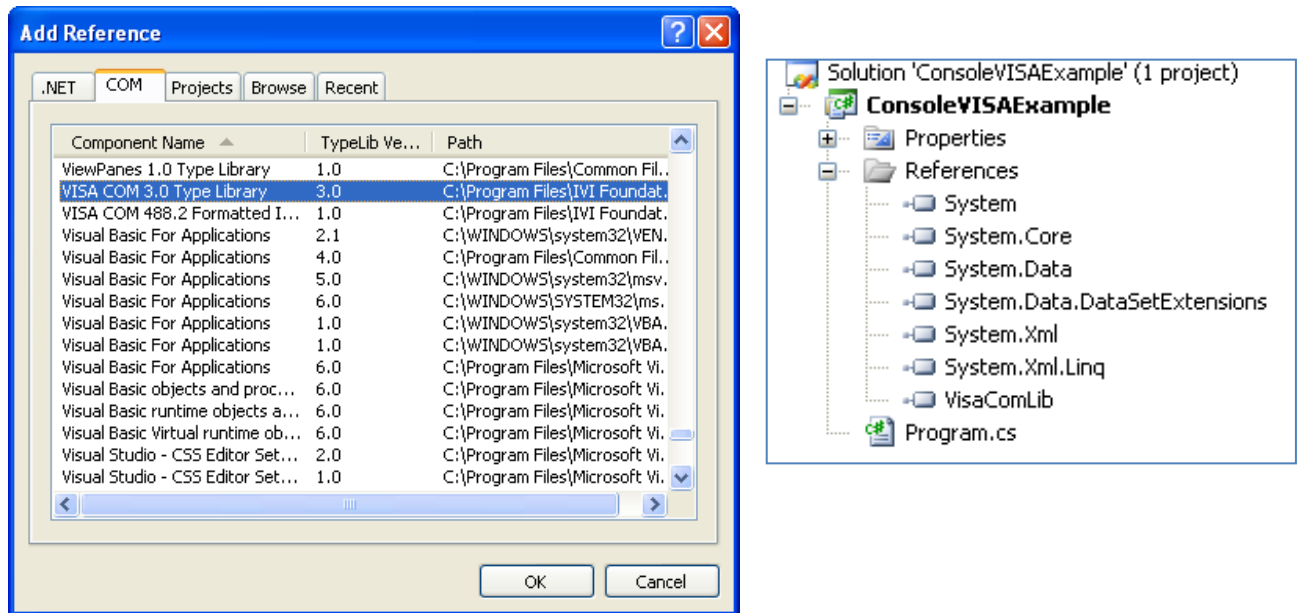

Figure D.2 Adding VISA COM 3.0 Library Reference to C# Console Application

When adding the VISA COM 3.0 reference to the project, a VisaComLib reference adds under the project "References" tree-node, as shown in Figure C.2. This reference is now available and permits the use of the following common components to open a connection to the LXI Device:

```
Using Ivi.Visa.Interop;
```

```
ResourceManager rMgr = new ResourceManagerClass();  
FormattedIO488 srcFgen = new FormattedIO488Class();
```

The basic components are in place now for the C# example program, which should work with the various VISA Libraries mentioned in **Section 4**. Other methods of connection are available, dependent upon the vendor's VISA Library custom components. Here is the source code for the C# example:

```

using System;
using System.Collections.Generic;
using System.Linq;
using System.Text;
// Reference the VISA Library
using Ivi.Visa.Interop;
namespace ConsoleVISAExample
{
    class Program
    {
        static void Main(string[] args)
        {
            // resource manager and message-based session manager
            ResourceManager rMgr = new ResourceManagerClass();
            FormattedIO488 srcFgen = new FormattedIO488Class();

            // Open I/O Connection to Function Generator

            srcFgen.IO = (IMessage)rMgr.Open("TCPIP0::MyFGEN::INSTR", AccessMode.NO_LOCK, 2000, null);
            // Could use "TCPIP0::MyFGEN::hislip0" or "TCPIP::MyFGEN::5025::SOCKET" if supported by device

            // Or, set Timeout using this method

            srcFgen.IO.Timeout = 2000;

            // Clear interface to make sure LXI Device parser will accept SCPI commands

            srcFgen.IO.Clear();

            // Reset the LXI Device and use Operation Complete to wait for Reset
            // Example shows multiple SCPI commands per line

            srcFgen.WriteString("*RST;*OPC?", true);
            string temp = srcFgen.ReadString();

            // Single command per line SCPI

            srcFgen.WriteString(":FREQ 10000", true);
            srcFgen.WriteString(":VOLT 1", true);
            srcFgen.WriteString(":VOLT:OFFS 0", true);
            srcFgen.WriteString(":OUTP ON", true);

            // ... rest of the Application Software

            // Close the connection and exit

            Console.WriteLine("done");
            srcFgen.IO.Close();
        }
    }
}

```

Note the VISA Address string choices for the Open() call. This permits different connections to the same device. The strings listed specify VXI-11 (INSTR), HiSLIP (hislip0), and Sockets (5025::SOCKET).

Mixing Direct I/O with IVI Driver

Section 4 introduced only the IVI Driver to control an LXI Device. *Section 5* discussed performance enhancements in the topic *Transactional Latency vs. Block Transfers*, where SCPI commands combined into a compound statement (e.g. “**FREQ 10000 ; VOLT 1 ; VOLT:OFFS 0**”) generate a single LAN transaction. Many IVI Drivers provide a means to access the “pass-through” method of sending native device commands to the LXI Device and allow access to the same I/O connection it uses for controlling the LXI Device.

IVI Drivers may not implement all capability found in an LXI Device, such as File System access, controlling the display, communication setup commands, and other non-measurement or non-signal generation features. The “pass-through” technique allows for 100% access to device capabilities.

The following code segment comes from an IVI Driver with a driver handle called *mDriver*. This handle references the *System* node to gain access to the underlying handle for Direct IO. Once obtained, the programmer has access to the same VISA COM methods used in the previous example.

```
// Method to use pass-through SCPI from IVI Driver

Ivi.Visa.Interop.IFormattedIO488 outVal;

outVal = mDriver.System.DirectIO;
outVal.WriteString("SYST:ERR?", true);

String respVal = outVal.ReadString();
```

Appendix D. What LXI Conformance Means

A majority of the major measurement instrument manufacturers established the first version of the LXI Standard in 2005 to bring about a common behavior for LAN equipped instruments. It was a huge step in compatibility such that a test engineer that builds a test system with LXI conformant devices can rely upon that LXI common behavior and programming tools.

The LXI specification consists of established LAN standards assembled together with many additional rules and recommendations to ensure compatibility. LXI conformance means the particular device adheres to the LXI specification and has passed some tough third party testing before claiming conformance.

All LXI conformant devices will connect to the LAN in a known and predictable manner, and they all have Web pages for describing their LAN communication and configuration. In addition, all LXI conformant devices must supply an IVI Driver (Interchangeable Virtual Instrument), which provides a common programming interface. Such compatibility never existed with LAN-based instruments prior to the LXI standard.

Prior to the LXI Standard, it was very difficult to mix LAN equipped instruments together into a Test System, especially from different vendors of equipment. In some cases, it was also difficult to integrate LAN equipped instruments from the same vendor. Unless that vendor had internal standards to follow between its Project Teams, this could easily happen.

If you see the LXI Logo on an instrument or on its Front Panel display, it will behave in a predictable manner when connected to the LAN. It will also include an IVI Driver with a common interface for programming that makes it much easier to develop test programs.